



**ESCUELA SUPERIOR POLITÉCNICA DEL LITORAL**

**Facultad de Ingeniería en Electricidad y Computación**

“DISEÑO DE UN SISTEMA DE VIDEO VIGILANCIA CON ALTA  
DISPONIBILIDAD PARA EL MONITOREO DE LAS CALLES Y  
AVENIDAS INTERNAS DE LA CIUDADELA LOS VERGELES”

**INFORME DE MATERIA INTEGRADORA**

Previo a la obtención del Título de:

**LICENCIADO/A EN REDES Y SISTEMAS OPERATIVOS**

ISABEL PATRICIA QUINDE ESTRADA

JIMMY FERNANDO JAMA GUALE

GUAYAQUIL – ECUADOR

AÑO: 2016

## **AGRADECIMIENTOS**

Agradezco a Dios por la vida, la fortaleza y la paciencia para poder continuar a pesar de los momentos difíciles y permitir que culminara esta etapa tan importante de mi vida.

Agradezco a mis padres Alberto Quinde Briones y Nelly Estrada Pazmiño, por la confianza, el amor y el apoyo incondicional en el transcurso de mi carrera, por enseñarme a no rendirme ante cualquier circunstancia que se me presente en el camino. A mis hermanas Adriana y Daniela por todo su cariño, por estar presentes en todo momento y por alentarme a seguir adelante.

A mi esposo Jimmy, por estar presente en todo momento conmigo compartiendo alegrías, tristezas y fracasos. A mi hija Meredith, quien es mi orgullo y mi gran motivación, que me impulsa cada día a superarme.

Agradezco de corazón a las personas que han aportado de manera directa e indirecta en la elaboración de esta tesis y han hecho que este éxito sea posible.

### **Isabel Quinde Estrada**

Agradezco a Dios por la fortaleza que me ha brindado para poder lograr esta meta tan importante en mi vida.

Agradezco a mis padres Tito Jama Quintero y Esperanza Guale Gómez por su confianza y apoyo incondicional durante todos estos años de carrera universitaria.

A mi esposa Isabel por ser ese apoyo en los momentos difíciles y estar ahí en las alegrías y tristezas. A mi hija Meredith que es mi más grande motivación para ser cada día una mejor persona.

A mi hermano Luis por todo su apoyo y por ser un ejemplo a seguir desde mi niñez.

Agradezco de todo corazón a todas las personas que de una u otra forma fueron parte de este logro.

### **Jimmy Jama Guale**

## **DEDICATORIA**

A Dios por la fortaleza para seguir adelante, a mis padres y hermanas por el apoyo incondicional en cada etapa de mi vida, por las palabras de aliento y la confianza depositada en mí. A mi abuelita por estar siempre pendiente, por sus grandes consejos y su apoyo incondicional. A mi esposo e hija que me acompañan en todo momento y me alientan a ser mejor cada día. Sin ellos este éxito no hubiera sido posible, les dedico con mucho cariño este trabajo.

**Isabel Quinde Estrada**

Dios, por darme la oportunidad de vivir y por estar conmigo en cada paso que doy, por fortalecer mi corazón e iluminar mi mente durante esta etapa de mi vida, a mis padres que día a día me alentaron a seguir adelante sin importar las adversidades, a mi esposa e hija que son mi motivación más grande para no rendirme jamás y a mi hermano por ser ejemplo de dedicación y esfuerzo. Este logro es gracias a ustedes.

**Jimmy Jama Guale**

## TRIBUNAL DE EVALUACIÓN

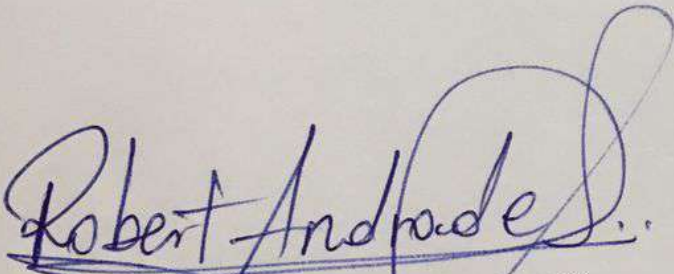

ING. Robert Andrade Troya  
**Profesor Evaluador**

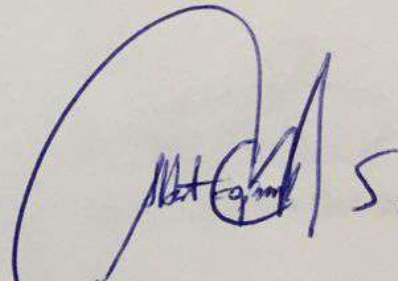

ING. Albert Espinal Santana  
**Profesor Evaluador**

## DECLARACIÓN EXPRESA

"La responsabilidad y la autoría del contenido de este Trabajo de Titulación, nos corresponde exclusivamente; y damos nuestro consentimiento para que la ESPOL realice la comunicación pública de la obra por cualquier medio con el fin de promover la consulta, difusión y uso público de la producción intelectual"

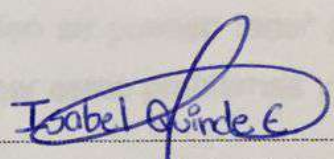

Isabel Quinde Estrada

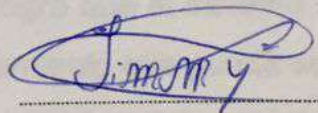

Jimmy Jama Guale

## RESUMEN

En el presente proyecto se muestra el diseño de un sistema de video vigilancia con alta disponibilidad para el monitoreo de la ciudadela Los Vergeles; ésta no cuenta con un patrullaje constante de la Policía Nacional por lo que existe un problema de seguridad y sus habitantes se han visto constantemente afectados por la delincuencia. A este problema se suma la falta de un UPC, dificultando aún más que se tome las medidas preventivas ante los eventos delictivos.

De este problema surge la idea de diseñar el sistema de video vigilancia, con el fin de monitorear las calles del sector y documentar los eventos delictivos que se puedan presentar; de esta forma mediante el respaldo del video se pueden tener pruebas contundentes que ayuden a las autoridades a solucionar estos problemas y brindar más seguridad a sus habitantes.

Para decidir el mejor diseño del sistema de video vigilancia se tomaron en cuenta aspectos como: calidad de imagen, capacidad de almacenamiento y facilidad de monitoreo. Considerando estos requerimientos se logró que el sistema de cámaras cuente con funciones de control de posición y acercamiento que pueda ser manejado remotamente desde el centro de monitoreo; así permitirá que la orientación de las cámaras pueda cambiar cuando sea necesario para dar seguimiento segundo a segundo de todo lo que suceda en la ciudadela, siempre manteniendo una buena calidad de imagen.

Este sistema de video vigilancia será una herramienta muy útil para los habitantes de la ciudadela Los Vergeles porque ayudará a reducir los eventos delictivos que se presentan diariamente, además se convertirá en un aliado de la Policía Nacional, pues ellos podrán identificar los puntos más críticos en cuanto a seguridad y tomarán las acciones correspondientes para poder contrarrestar la delincuencia. Con el aumento de la seguridad en el sector se podrá tener una mejor calidad de vida para todas las familias que habitan en la ciudadela Los Vergeles.

## ÍNDICE GENERAL

AGRADECIMIENTOS.....	ii
DEDICATORIA.....	iii
TRIBUNAL DE SUSTENTACIÓN .....	iv
DECLARACIÓN EXPRESA.....	v
RESUMEN.....	vi
ÍNDICE GENERAL .....	vii
CAPÍTULO 1.....	1
1. LEVANTAMIENTO DE INFORMACIÓN.....	1
1.1 Planteamiento del problema .....	2
1.2 Objetivos generales .....	2
1.3 Objetivos específicos.....	2
1.4 Justificación .....	3
1.5 Alcance del proyecto .....	3
CAPÍTULO 2 .....	5
2. DISEÑO DE LA SOLUCIÓN .....	5
2.1 Ubicación de cámaras .....	6
2.2 Modelo de cámaras .....	7
2.3 Visualización del alcance de las cámaras .....	8
2.4 Conexión de las cámaras PTZ .....	11
2.4.1 Conexión con cable FTP .....	11
2.4.2 Conexión con fibra óptica .....	12
2.4.3 Ubicación y características de los switches .....	13
2.5 Almacenamiento de los videos .....	15

2.5.1	Calidad de video .....	16
2.6	Ubicación de los centros de monitoreo .....	17
2.6.1	Descripción de los equipos de red .....	19
2.7	Respaldo eléctrico .....	20
2.8	Software de monitoreo .....	22
2.9	Análisis de la cantidad de dispositivos de red .....	23
2.10	Direccionamiento .....	24
2.11	Seguridad de la red de videovigilancia .....	25
CAPÍTULO 3.....		27
3.	GESTIÓN OPERATIVA DE LA SOLUCIÓN .....	26
3.1	Turno de trabajo .....	26
3.2	Alquiler del segundo centro de monitoreo .....	26
3.3	Conexión con el centro de monitoreo .....	27
3.4	Proveedores de Internet.....	27
3.5	Mantenimiento de equipos.....	27
3.6	Tabla de costos operativos .....	27
3.7	Plan de pagos para el sistema de video vigilancia .....	28
CAPÍTULO 4.....		29
4.	PLAN DE IMPLEMENTACIÓN Y ANÁLISIS ECONÓMICO .....	29
4.1	Instalación de cámaras.....	29
4.2	Cableado .....	29
4.3	Construcción y remodelación de los centros de monitoreo .....	29
4.4	Construcción del UPC .....	30
4.5	Instalación de los equipos de red .....	30



4.6	Configuración de los equipos .....	30
4.7	Diagrama de Gantt .....	32
4.8	Análisis económico .....	33
CONCLUSIONES Y RECOMENDACIONES .....		34
BIBLIOGRAFÍA.....		35
ANEXOS .....		36

## CAPÍTULO 1

### 1. LEVANTAMIENTO DE INFORMACIÓN.

La ciudadela Los Vergeles se encuentra ubicada al norte de la ciudad de Guayaquil junto a la avenida Francisco de Orellana, entre las ciudadelas Huancavilca Norte y Las Orquídeas.

Los Vergeles es una ciudadela con muchos años de antigüedad, en los últimos 15 años se ha expandido hasta convertirse en uno de los sectores más grandes de la ciudad de Guayaquil con una extensión de 200 hectáreas en total como se puede observar en la Figura 1.1.

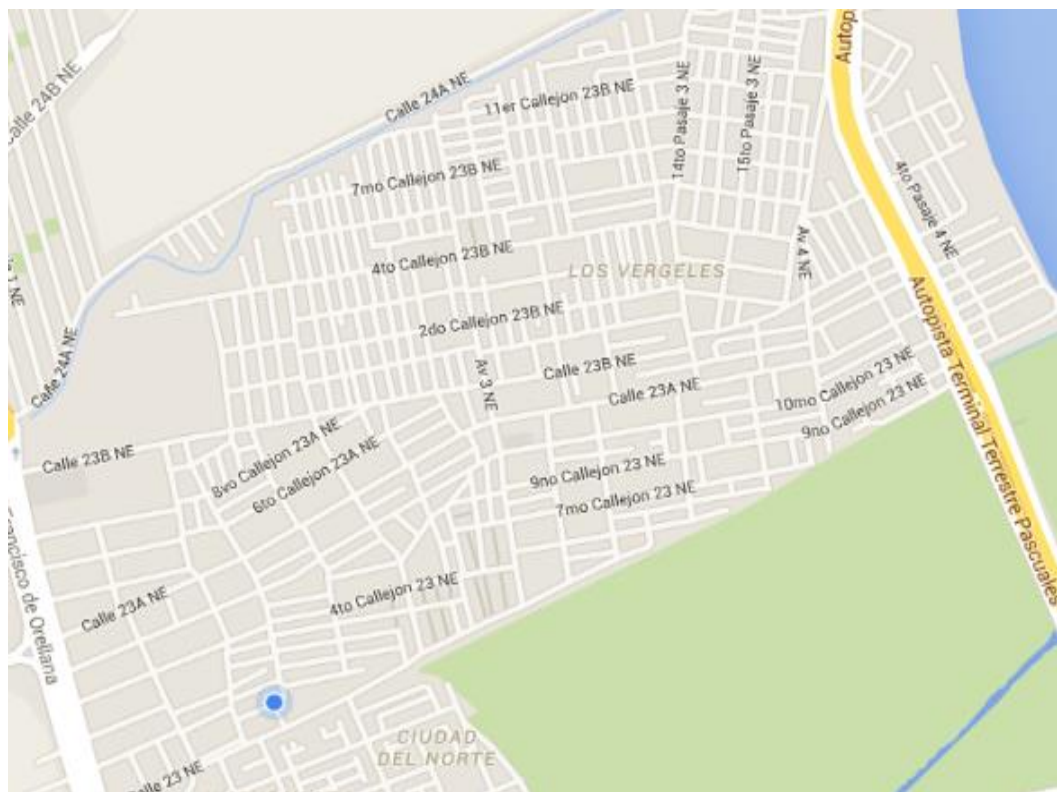

**Figura 1.1: Plano de la ciudadela “Los Vergeles”**

En la Figura 1.1 se detalla la extensión que conforman las 11 etapas de la ciudadela y los nombres de las principales calles y avenidas.

### **1.1 Planteamiento del problema.**

En la ciudadela Los Vergeles existe un problema de seguridad que preocupa a sus habitantes: la delincuencia ha aumentado en los últimos meses. Se han reportado muchos casos de asaltos a mano armada, robos a viviendas, robos de autos, venta y consumo de drogas.

Las personas que se ven más afectadas por estas eventualidades son quienes habitan en la primera etapa de la ciudadela Los Vergeles, y muchas veces no denuncian estos casos o no se muestran dispuestos a colaborar con la policía por temor a represalias por parte de los delincuentes.

La Policía Nacional patrulla el sector un promedio de dos veces al día, pero no es suficiente, la falta de un UPC al que los habitantes puedan acudir en alguno de estos casos dificulta una rápida acción por parte de la Policía Nacional.

### **1.2 Objetivos generales**

Diseñar un sistema de video vigilancia que mejore la seguridad y permita el monitoreo en la primera etapa de la ciudadela Los Vergeles, con ayuda de la Policía Nacional, para lograr una mejor atención a los habitantes ante los eventos delictivos ocurridos en el sector.

### **1.3 Objetivos específicos**

- Diseñar una red de cámaras de vigilancia que cubra las avenidas y calles internas de la ciudadela Los Vergeles. El sistema de video vigilancia debe funcionar las 24 horas del día los 365 días del año.
- Diseñar un centro de monitoreo en el que se tenga control de las imágenes de las cámaras.
- Establecer una conexión entre el centro de monitoreo y La Policía Nacional.
- Establecer el respaldo de energía eléctrica del centro de monitoreo para que pueda funcionar hasta 5 horas continuas en caso de una falla eléctrica.

- Diseñar para que el sistema de video vigilancia almacene los videos por 30 días antes de ser eliminados.
- Utilizar un sistema de almacenamiento que permita archivar el video captado por el centro de monitoreo.
- Capacitar al personal que trabajará en el centro de monitoreo.

#### **1.4 Justificación**

En la actualidad las cámaras de video vigilancia son el método más eficaz para ayudar a mejorar la seguridad de una ciudad, empresa o vivienda.

El presente proyecto tiene como finalidad diseñar un sistema de video vigilancia con alta disponibilidad, para aumentar la seguridad de la ciudadela Los Vergeles debido a los eventos delictivos que ocurren a menudo.

El diseño del sistema de video vigilancia brindará a los habitantes más tranquilidad al salir de sus hogares y seguridad al momento de reportar algún evento delictivo, además será una ayuda para la Policía Nacional al momento de abrir una investigación.

#### **1.5 Alcance del proyecto.**

El sistema de video vigilancia será diseñado para la primera etapa de la ciudadela Los Vergeles, la cual cuenta con 910 casas aproximadamente sobre una extensión de 28 hectáreas y un total de 40 Manzanas. Tiene alrededor de 4500 habitantes de clase media baja y se encuentra junto a la avenida Francisco de Orellana.

Se puede observar en la Figura 1.2 el plano de la primera etapa de la ciudadela Los Vergeles detallando el nombre de las calles y avenidas internas principales de la ciudadela.

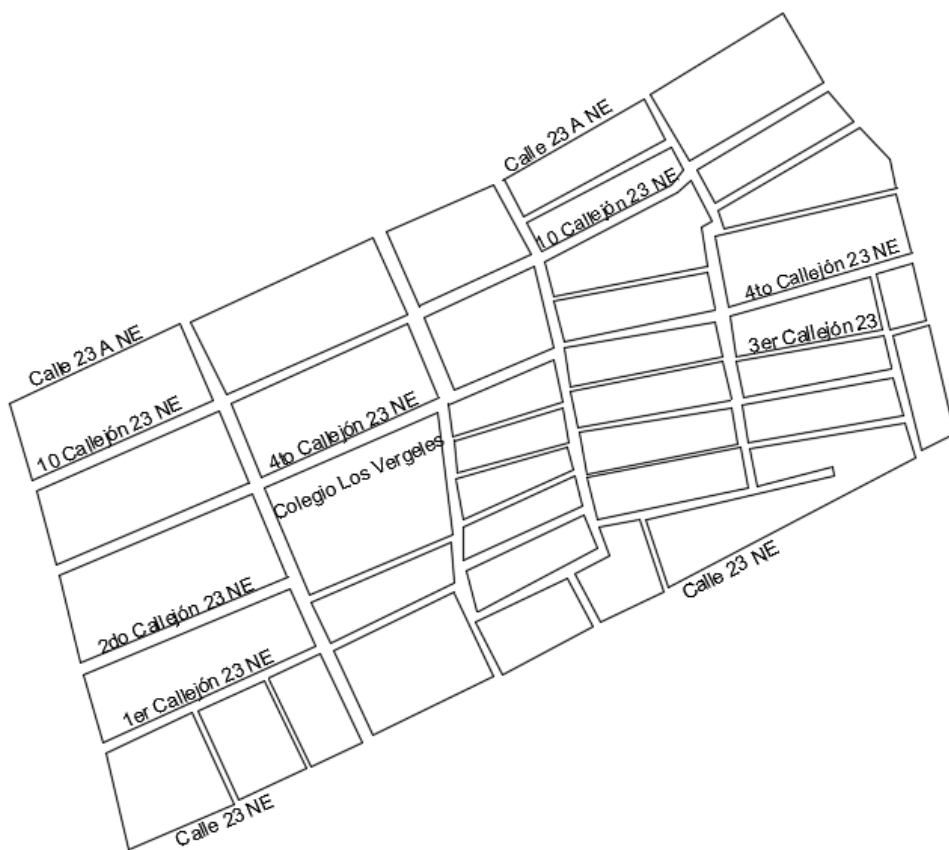

**Figura 1.2: Plano de la primera etapa de la ciudadela “Los Vergeles”**

## CAPÍTULO 2

### 2. DISEÑO DE LA SOLUCIÓN.

Analizando los requerimientos solicitados por los habitantes de la ciudadela Los Vergeles, se escogió como solución diseñar un sistema de video vigilancia con alta disponibilidad utilizando cámaras de movimiento tipo PTZ; éstas se conectarán a 2 centros de monitoreo por medio de fibra óptica y cable FTP, el cableado será de tipo aéreo.

Para la ubicación de las cámaras y de los centros de monitoreo se creó un sistema de códigos; en la Figura 2.1 se muestra la asignación de los códigos a cada manzana de la ciudadela Los Vergeles, de esta forma se busca facilitar la identificación de cada una de ellas.

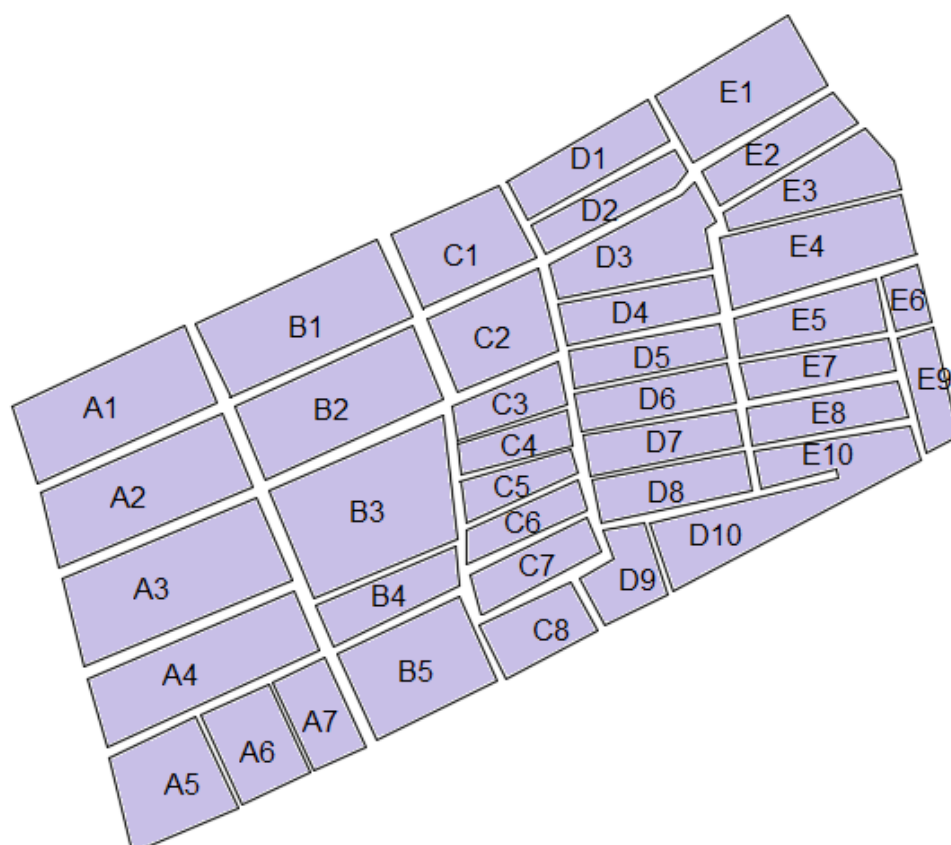

**Figura 2.1 Asignación de códigos a las manzanas de la ciudadela Los Vergeles**

### 2.1 Ubicación de cámaras.

Para la instalación de las cámaras se utilizarán los postes de alumbrado público de la ciudadela, se colocarán tres modelos de cámaras dependiendo de la extensión de cada manzana. En la Figura 2.2 se observa como estarán distribuidas las cámaras en la ciudadela Los Vergeles.

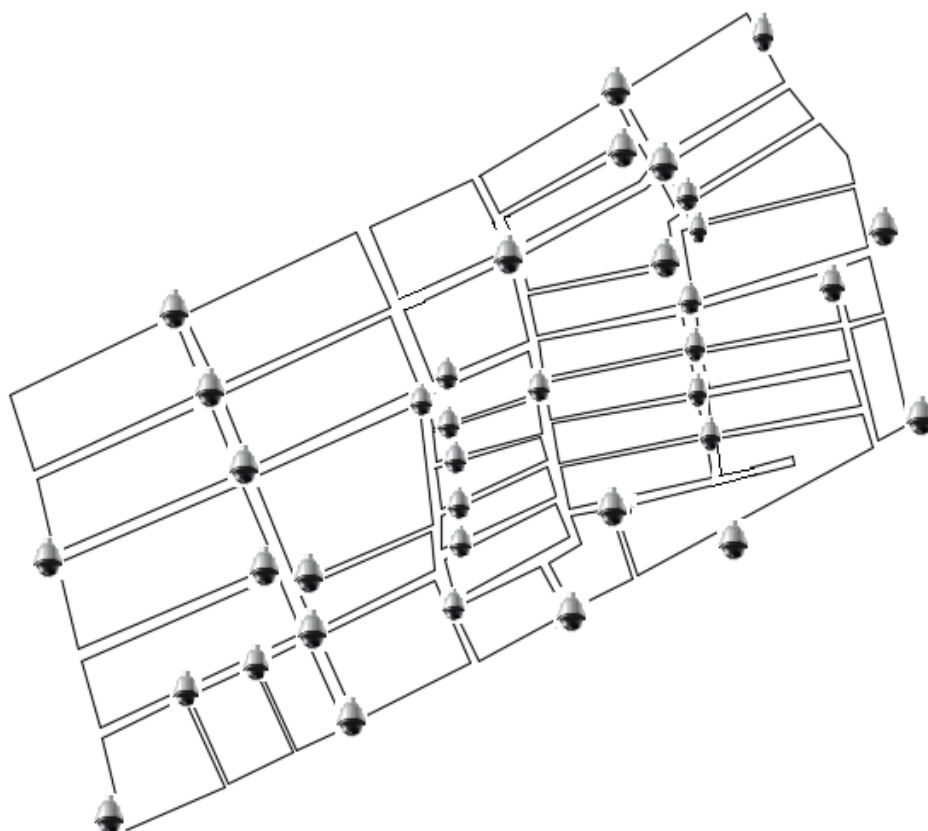

**Figura 2.2: Distribución de las cámaras en la ciudadela “Los Vergeles”**

El diseño del sistema de video vigilancia cuenta con un total de 45 cámaras de movimiento tipo PTZ, que cubrirán todas las calles y avenidas internas de la ciudadela Los Vergeles. Se utilizarán cámaras marca Hikvision porque ofrece una gama de productos con muy buenas características y a un costo accesible, estos

equipos son la mejor alternativa para cubrir los requerimientos del diseño del sistema de video vigilancia. En la Tabla 1 se muestra la cantidad de cámaras a utilizar y la cantidad centros de monitoreo que se construirán.

<b>Modelo</b>	<b>Cantidad</b>
Cámara IP tipo PTZ	45
Centros de monitoreo	2

**Tabla 1: Cantidad de cámaras.**

## **2.2 Modelo de cámara.**

El modelo de cámara a utilizar es el DS-2DE5174-AE de la marca Hikvision; este modelo permite tener una buena calidad de imagen a una distancia de hasta 200 metros, gracias a su función de patrón de movimiento programable brinda la posibilidad de configurar el escaneo constante de todas las calles, incluyendo el acercamiento a los puntos más lejanos para una mejor visualización. En la Tabla 2 se muestra las características de la cámara.

<b>Modelo Hikvision DS-2DE5174-AE</b>
Compresión de video H:264
Conexión ethernet por RJ-45
Fuente de poder de 24VAC - 22w
Función día noche con filtro ICR
Lente varifocal 4.7 – 94 mm
Protección IP66
Puede recibir alimentación vía PoE
Resolución: 1280x960p
Sensor de imagen: CMOS 1/3"
Video hasta 30 FPS/1080p
Zoom óptico de 30x
Patrón de escaneo

**Tabla 2: Características del modelo DS-2DE5174-AE**

En la Figura 2.3 se muestra una imagen de la cámara que se utilizará en diseño.





HIKVISION  
DS-2DE5174-AE

220mm (A) x 305mm(H)

**Figura 2.3: Modelo cámara tipo PTZ**

### **2.3 Visualización del alcance de las cámaras**

Se realizaron pruebas de la visualización y alcance de las cámaras utilizando el software IP Video System Desing Tool, en la resolución más alta se podrá entender claramente lo que se encuentra hasta 200 metros de distancia desde el poste donde se ubicarán las cámaras.

En las Figuras: 2.4, 2.5 y 2.6 se muestra como se verán las imágenes con el acercamiento.

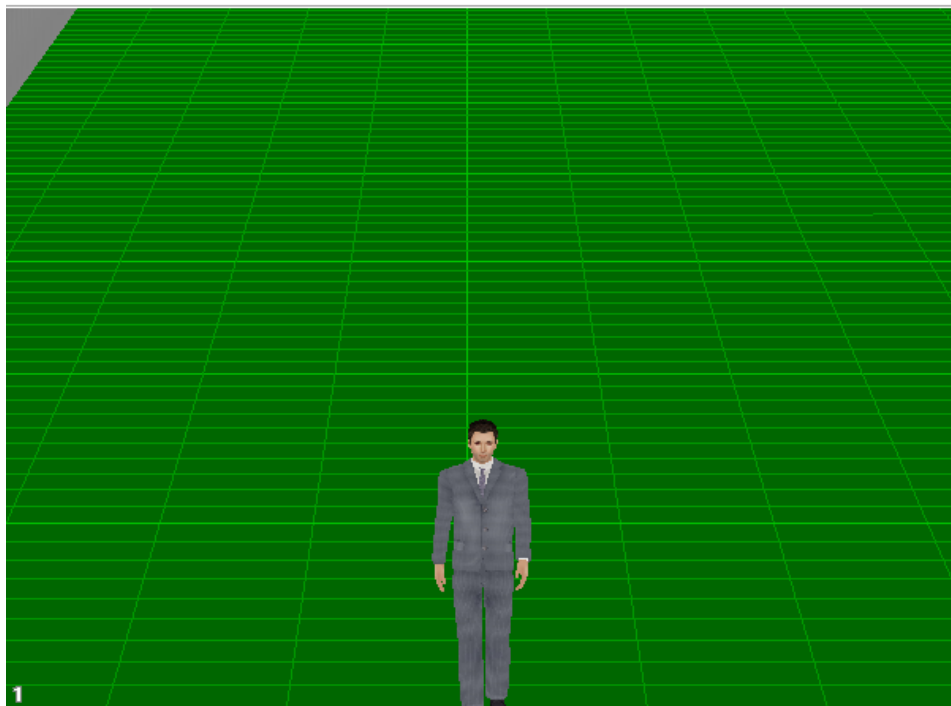

**Figura 2.4: Alcance de visión a 50m**

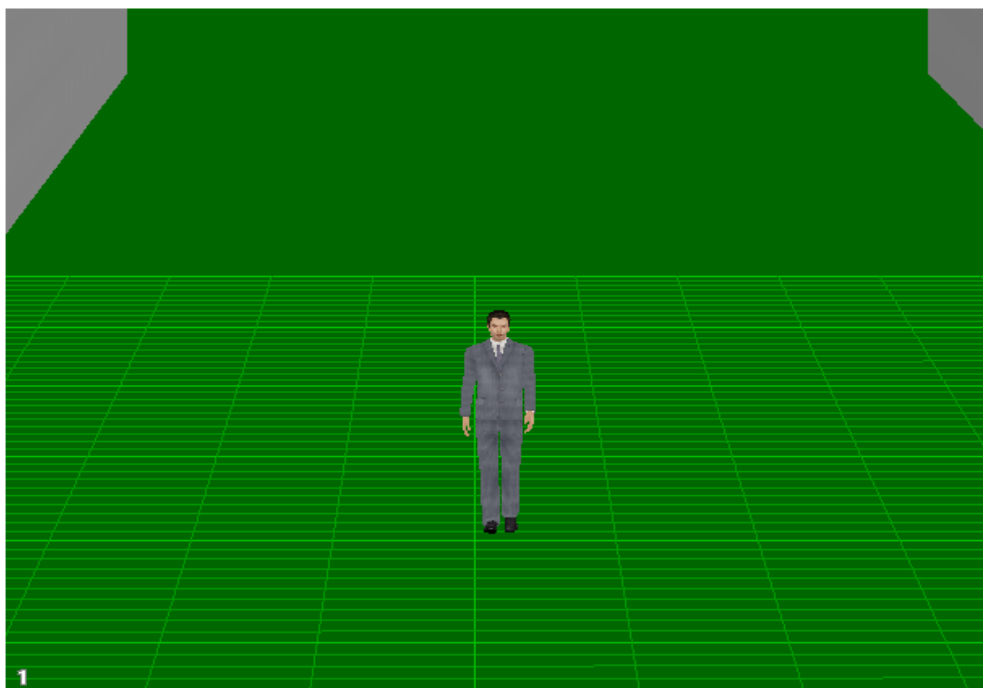

**Figura 2.5: Alcance a 100 m**

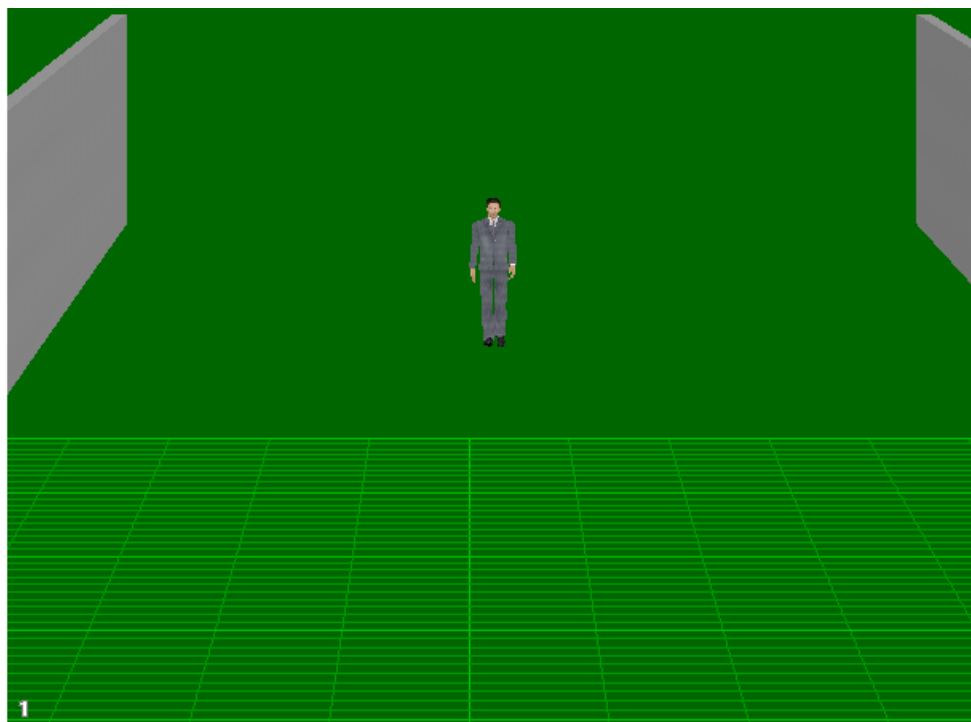

**Figura 2.6: Alcance a 200 m**

## 2.4 Conexión de las cámaras PTZ.

Para la conexión entre las cámaras de vigilancia y los equipos del centro de monitoreo se usarán dos tipos de cables, en función a la distancia que deba recorrer:

- Cable FTP CAT6A.
- Fibra óptica multimodo OM3.

### 2.4.1 Conexión con cable FTP.

Las cámaras que se encuentren cerca de los centros de monitoreo a una distancia menor a los 100 metros se conectarán a éste directamente; se usará cable FTP marca **Panduit categoría 6A** para exteriores.

Este cable puede manejar un ancho de banda de 550 MHz y una velocidad de hasta 10 Gbps, a diferencia del cable Cat6 que solo tiene un ancho de banda 250MHz y una velocidad de 1Gbps.

En las cámaras que se encuentran a una distancia superior a 100 metros de los centros de monitoreo, se colocará un extensor PoE Startech con las siguientes características:

- Extiende la conexión PoE sobrepasando el límite de 100 metros.
- Compatibilidad con estándar IEEE 802.3af (PoE) y IEEE 802.3at (Poe+).
- No requiere fuente de alimentación eléctrica adicional.

El cable FTP tiene un límite de instalación de 100 metros, al utilizar una extensión PoE Startech es posible ampliar ese límite a 100 metros más de una forma sencilla y segura.

La extensión Startech no necesita una fuente adicional de energía, se alimentará mediante un switch PoE.

### 2.4.2 Conexión con fibra óptica.

Los switches que recibirán la conexión de las cámaras más alejadas se conectarán al centro de monitoreo a través de fibra óptica, esta será de tipo multimodo 50/125 de 6 hilos marca Panduit estándar OM3.

Las ventajas de usar fibra óptica son:

- Se puede utilizar para grandes distancias.
- No produce interferencias.
- Resistencia al calor, frío y corrosión.
- Facilidad para localizar daños.

En la Tabla 3 se muestra las características principales del estándar de fibra óptica OM3.

	Longitud de onda	
	850 nm	1300 nm
<b>Fast Ethernet 100 Mbps</b>	300 m	2000 m
<b>Gigabit ethernet 1Gbps</b>	900 m	550 m
<b>10 Gigabit Ethernet</b>	300 m	300 m

**Tabla 3: Característica de Fibra Óptica OM3**

Este tipo de cable puede soportar un ancho de banda de 1Gbps a una distancia de 500 metros, de esta forma se puede brindar una conexión de excelente calidad con resistencia a las interferencias electromagnéticas.

Con la fibra óptica OM3 se conseguirá mayor velocidad de transmisión que con las versiones anteriores, gracias a esto se garantiza un óptimo funcionamiento del sistema de video vigilancia.

En la Figura 2.7 se detalla cómo se realizará la conexión de los dispositivos de red para el diseño del sistema de video vigilancia.

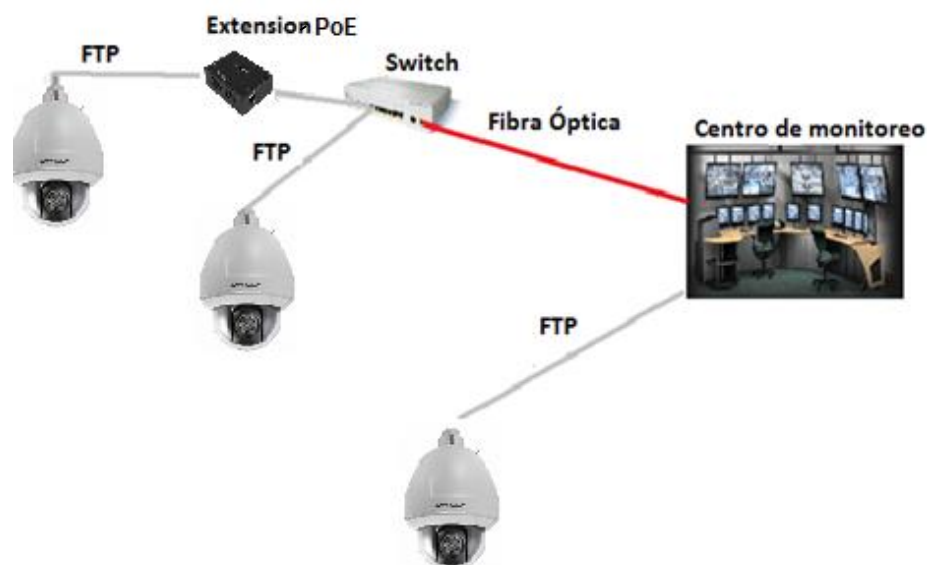

**Figura 2.7: Conexión de los dispositivos de red.**

#### **2.4.3 Ubicación y característica de los switches.**

Los switches que estarán conectados al primer centro de monitoreo se encuentran en las manzanas con códigos A3 y A6, a los que se conectan un total de 11 cámaras.

Los switches que estarán conectados al segundo centro de monitoreo se encuentran en las manzanas con códigos E2 y E10, a los que se conectarán un total de 12 cámaras.

En la ubicación de cada uno de estos 4 switches se construirá un armario de concreto, en el que además del switch correspondiente tendrá un UPS que brindará el respaldo eléctrico necesario para mantener la disponibilidad del sistema de video vigilancia.

En la Figura 2.8 se muestra como estarán conectados los switches a cada centro de monitoreo.

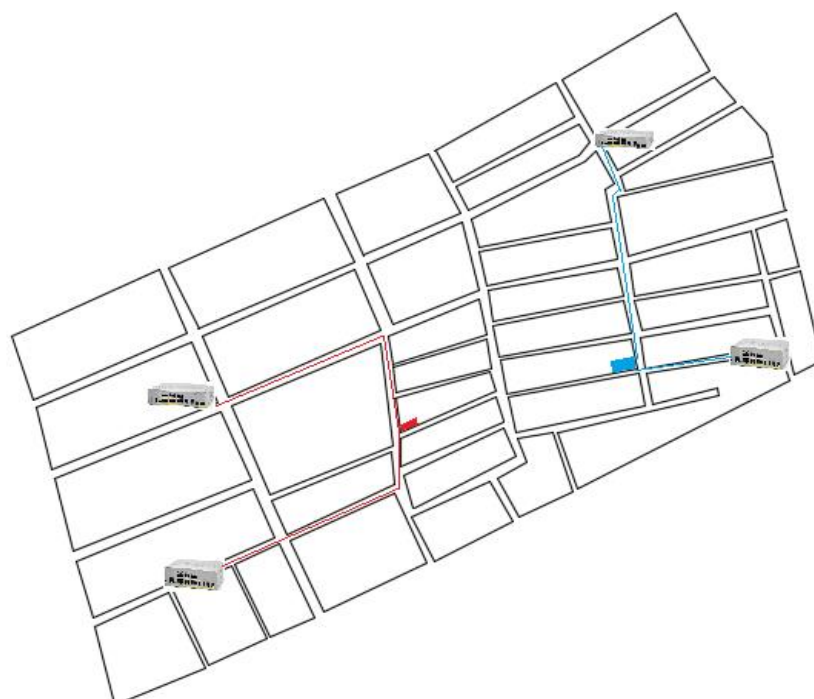

**Figura 2.8 Ubicación de los switches en la ciudadela “Los Vergeles”**

Para el diseño del sistema de video vigilancia se escogió switches marca Cisco, se utilizarán los modelos Cisco Catalyst 3560CX-12PD-S y Cisco Catalyst 3560CX-8PD-S en la Tabla 4 se muestran las características:

<b>Cisco Catalyst 3560CX-12PD-S</b>	<b>Cisco Catalyst 3560CX-8PD-S</b>
Switch de 12 puertos.	Switch de 8 puertos.
Switch de capa 3.	Switch de capa 3.
Alimentación por PoE de 240w.	Alimentación por PoE de 240w.
Trabaja a 10Gb tanto en los puertos ethernet como en los SFP.	Trabaja a 10Gb tanto en los puertos ethernet como en los SFP.
Consumo eléctrico: 278W con todos los puertos usando Poe.	Consumo eléctrico: 278W con todos los puertos usando Poe.
Consume 24.9W sin usar PoE.	Consume 24.9W sin usar PoE.

**Tabla 4: Características del switch Cisco Catalyst 3560CX-12PD-S y 3560CX-8PD-S**

Este tipo de switch es la opción más óptima para el diseño de video vigilancia, tiene alimentación por PoE lo que permitirá energizar las cámaras por medio de un solo cable tipo ethernet.

Las medidas de los switches son: 4.44cm de altura x 26.9cm de ancho x 23.8cm de profundidad y el peso es de 2.31 kg.

En la Tabla 5 se muestra la cantidad de dispositivos de red y cableado que se utilizarán para el diseño del sistema de video vigilancia.

Recursos de red	Switch 8 puertos(u)	Switch 12 Puertos(u)	Extensor Startech(u)	Fibra óptica(mts)	Cable FTP(mts)
Cantidad	3	1	10	1235	3461

**Tabla 5: Cantidad de recursos de red.**

## 2.5 Almacenamiento de los videos.

Para el almacenamiento de las grabaciones se utilizarán equipos NVR (Network Video Recorder): es un videograbador con gran capacidad de almacenamiento, que permite una mayor calidad de imagen al archivar los videos.

El modelo que se utilizará es **Hikvision DS-9664NI-XT**, este equipo tiene la capacidad de usar hasta 16 discos duros de 4 TB cada uno, de esta forma se podrá almacenar una gran cantidad de tiempo de grabación en el caso de que deba ser analizada posteriormente. En la Tabla 6 se muestran las características de los NVRs que serán utilizados para el almacenamiento de videos.

<b>Hikvision DS-9664NI-XT</b>
Formato múltiples H.264
Puede tener hast 64 canales para grabación
Diversos modos de grabación: Manual, programa horario incluyendo evento, emergencia.
Deteccion de movimientos
Salida de video HDMI
Alarma de cámara
Los discos duros pueden ser de hasta 4 TB
Consumo aproximado de 45W

**Tabla 6: Características de NVR**



Este modelo NVR tiene una gran capacidad de almacenamiento y el software que viene incluido permite realizar funciones muy importantes como la detección de movimientos.

Los videos se almacenarán por 30 días antes de ser eliminados; cuando suceda algún evento delictivo este video se extraerá del videograbador para ser archivado por 90 días en servidores de almacenamiento, operados por los técnicos encargados en el centro de monitoreo. Si alguno de estos videos es solicitado por la Policía Nacional como prueba de un delito se archivará por el tiempo que sea requerido.

Para este servidor se necesitará:

- Una capacidad de disco duro de 10 Tb.
- Un procesador Intel Core i3 de 1.7 Ghz.
- 4 Gb de Memoria RAM.

Ya que este servidor almacenará videos ocasionalmente no necesita tener grandes prestaciones.

### 2.5.1 Calidad de video

Para determinar la capacidad de almacenamiento requerido se utilizó el software IP Video System Desing Tool, considerando la resolución de la cámara con la compresión H.264-10 (Alta Calidad) y con una tasa de 30 FPS (Imagen por segundo). En la Figura 2.9 se muestra los resultados de la simulación.

Resolución	Compresión	Tamaño Frame*, KB	FPS	Días	Cámar...	Grabación %	Ancho de ban...	Espacio del di...	Bitrate,...
1280x960 (1.22MP)	H.264-10 (Calidad 14	14	30	30	45	100	154,83	50164,5	3441

Total FPS	Espacio disco,GB	Ancho banda, Mbit/s
1350	50164,5	154,83

**Figura 2.9: Software para el cálculo de almacenamiento requerido**

Cada cámara grabará con una resolución de 1280x960p y requerirá 1114,8 Gb de almacenamiento por mes, lo que da un total de 50164,5Gb.

En la Tabla 7 se muestra la cantidad de almacenamiento que requieren las cámaras para archivar los videos por un mes.

Los switches de los centros de monitoreo que reciben la conexión de todas las cámaras manejarán un ancho de banda de 79,22 Mb para cada centro de monitoreo.

Modelo	Almacenamiento por mes (Gb)	Cantidad de cámaras (u)	Total (Gb)
modelo DS-2DE5174-AE	1114.80	45	50164.50
30 % adicional			0.30
Total			65213.85

**Tabla 7: Almacenamiento para las cámaras de video**

El resultado que da el software es de un almacenamiento de 66.40 Tb; pero por factores como luz o cantidad de movimiento en escena este valor puede variar, por este motivo recomienda aumentar en un 30% la cantidad de almacenamiento y esto da un almacenamiento total de 86.32 Tb.

El software que permitirá la visualización de las cámaras será **IVMS-4200**, el cual es compatible con sistemas operativos Windows y tiene la capacidad de visualización en vivo de hasta 4 monitores hasta 64 cámaras por monitor.

De acuerdo a los requisitos del software de visualización las características de los Servidores serán las siguientes:

- Microsoft Windows 10 Professional 64bit.
- Intel Core i7-860.
- RAM: 6GB.
- Disco duro de 1Tb.

## 2.6 Ubicación de los centros de monitoreo.

Se diseñarán dos centros de monitoreo en la ciudadela Los Vergeles; el primer centro de monitoreo estará ubicado en la Mz. 203 V. 27 1er Callejón 23 y 3er Pasaje 1A en el tercer piso de la vivienda, tiene un área de construcción de 64m<sup>2</sup>

(8mts x 8mts), el dueño puso a disposición este piso para la instalación del centro de monitoreo.

El segundo centro de monitoreo se construirá en la Mz. 180 V. 25 callejón Julia Santana y 7mo pasaje 1ª, es un terreno vacío con un área de 92 m<sup>2</sup> disponible para la compra.

Tomando como referencia el área de construcción del primer centro de monitoreo, se construirá el segundo centro de monitoreo con similares dimensiones para que mantengan una misma distribución de los equipos de red.

Los racks estarán ubicados en el fondo de la habitación, tienen una medida de 600mm de ancho por 900mm de fondo, se utilizarán racks del modelo Nexxt AW220NXT62 de 37u.

En los racks se instalarán: switches, NVRs, UPS y el Servidor de almacenamiento de video adicional de la red.

En cada centro de monitoreo se instalarán 2 televisores marca Samsung de 50", serán ubicados en la pared a una distancia de 2mts de la pared que esta hacia la calle, los televisores tienen una medida de 1,13 m de ancho por 70cm de alto.

El acondicionador de aire estará ubicado en la pared del fondo de la habitación cerca de los Racks, de esta forma se distribuirá de mejor manera el enfriamiento.

En las Figuras 2.10 y 2.11 se muestra la distribución de los centros de monitoreo.



**Figura 2.10 Distribución de los equipos en el primer centro de monitoreo**



**Figura 2.11: Distribución de los equipos en el segundo centro de monitoreo**

### **2.6.1 Descripción de los equipos de red en el centro de monitoreo.**

El modelo del switch principal de la red de video vigilancia es el modelo Cisco Catalyst WS-C3850-24XS al que estarán conectados: el switch Cisco Catalyst WS-C3560X-24P-L, el NVR, el acceso a internet y los servidores con el software de visualización.

Al modelo Cisco Catalyst WS-C3560X-24P-L se conectarán las cámaras cercanas al centro de monitoreo y los switches 3560 de 12 y 8 puertos, al que estarán conectadas las cámaras más lejanas.

En la Tabla 8 se muestran las características de los switch Cisco Catalyst WS-C3850-24XS Y Cisco Catalyst WS-C3560X-24P-L.

<b>Cisco Catalyst WS-C3850-24XS</b>	<b>Cisco Catalyst WS-C3560X-24P-L</b>
Switch de 24 puertos.	Switch de 24 puertos.
Switch de capa 3.	Switch de capa 3.
Trabaja a 10Gb tanto en los puertos Ethernet como en los SFP.	Alimentación por PoE de 435W.
Consumo eléctrico como máximo 187W.	Trabaja a 10Gb tanto en los puertos ethernet como en los SFP.
Tiene tecnología Cisco stack wise – 480, permite una escalabilidad con 480Gps de throughput.	Consumo eléctrico: 660W con todos los puertos usando Poe.
Fuente de poder redundante.	Consume 99.3W sin usar PoE.
Soporta QoS y netflow.	

**Tabla 8: Características de los switches**

## 2.7 Respaldo eléctrico

Para un óptimo funcionamiento del sistema de video vigilancia es necesario, que cuando exista una falla eléctrica el sistema sea capaz de seguir funcionando con normalidad hasta que la electricidad sea reestablecida.

Para estos casos el respaldo eléctrico del diseño de video vigilancia estará compuesto por dos elementos:

- UPS (sistema de alimentación ininterrumpida) que impedirá que los dispositivos de red y cámaras se apaguen inesperadamente.
- Generador eléctrico a base de combustible, que mantendrá con energía eléctrica a todos los depósitos y cámaras hasta que la energía se normalice.

En la Tabla 9 se muestra el consumo total de los equipos de red, para elegir el modelo de generador eléctrico y UPS a utilizar.

Equipo de red	consumo de w	Cantidad de equipos	Consumo total
DS-2DE5174-AE	25	45	1125.00
3560CX-12PC-S	275.2	1	275.20
3560CX-8PC-S	269.1	3	807.30
WS-C3850-24P	550	2	1100.00
WS-C3560X-24P-L	660	2	1320.00
Servidor de almacenamiento	550	2	1100.00
DS-9664NI-XT	45	2	90.00
Servidor de visualización	650	4	2600.00
Total W			8417.50

**Tabla 9: Cálculo del consumo eléctrico de los equipos de red.**

Se tiene un total de consumo de 8417.5W entre los dos centros de monitoreo, se le agregará un 20% como seguridad al valor total:

- El primer centro de monitoreo tiene un consumo de 4193,2 +725, total 4918,2 \*20% = 5902W
- El segundo centro de monitoreo tiene un consumo de 4224,3 + 725, total 4949,3 \*20% =5939,16W

Para cubrir estos requerimientos se utilizará el generador eléctrico modelo Kaiser diésel insonorizado de 6000W este equipo brindará la alimentación eléctrica a todo el centro de monitoreo hasta por 7 horas con el tanque de combustible lleno. En Tabla 10 se muestran sus principales características.

<b>Generador Eléctrico Modelo Kaiser Diésel Insonorizado 6000w</b>
Cuenta con un motor OHV diésel de 4 tiempos potencia real de 420cc.
Incluye arranque manual y eléctrico
Filtro de gasóil grande como el de los vehículos y un mando a distancia
Es silencioso

**Tabla 10: Características del generador eléctrico modelo kaiser diésel insonorizado 6000w.**

Debido a que el modelo de generador eléctrico no es de encendido automático se usará un UPS que mantenga el centro de monitoreo funcionando hasta que encienda el generador; el modelo de UPS que se utilizará es el modelo PT600RT POWERTRONIC. En la Tabla 11 se muestra las principales características:

<b>Ups Pt600rt Powertronic</b>
Capacidad: 6000 W
Formato Rack / Tower
Voltaje de entrada 230v, salida 230V
On-line doble conversión
Panel LCD
Opción banco de batería externo

**Tabla 11: Características del UPS modelo PT600RT POWERTRONIC**

## 2.8 Software de monitoreo

Se implementará un software de monitoreo para los dispositivos de red, para esto se utilizará el programa Zabbix, es un software libre que permite el monitoreo de los dispositivos de red mediante ICMP, aquí se programarán una serie de alarmas que se activarán en caso de detectar si algún dispositivo está fuera de línea manteniendo así un control ágil de los dispositivos de red.

El centro de monitoreo contará con conexión al ECU911 para los casos en que se requiera ayuda de la Policía Nacional se pueda tener una respuesta inmediata.

En la Figura 2.12 se muestra una imagen del software de monitoreo que se utilizará en los servidores.



Figura 2.12: Software de monitoreo del estado de los equipos de red.

## 2.9 Análisis de la cantidad de dispositivos de red.

En la Tabla 12 se detalla la cantidad de dispositivos y recursos de la red que se instalarán para el óptimo funcionamiento del sistema de video vigilancia.

Dispositivos y recursos de red	Cantidad
Cisco Catalyst ws-c4500x-f-16s	2
Cisco Catalyst WS-C3850-24XS	2
Extensión WJ-HDE400	2
Panasonic WJ-NV300	2
Televisores Samsung 50"	4
Servidores de visualización	4
Servidores de almacenamiento	2
Generadores electricos	2
UPS	2
Rack	2

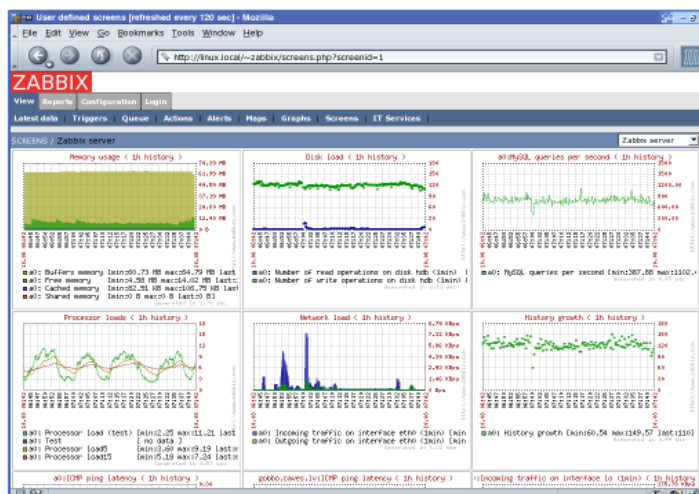
Tabla 12: Cantidad de Dispositivos de red a utilizar



En la Figura 2.13 se muestra la conexión completa de las cámaras de video hasta los dispositivos de red del centro de monitoreo.

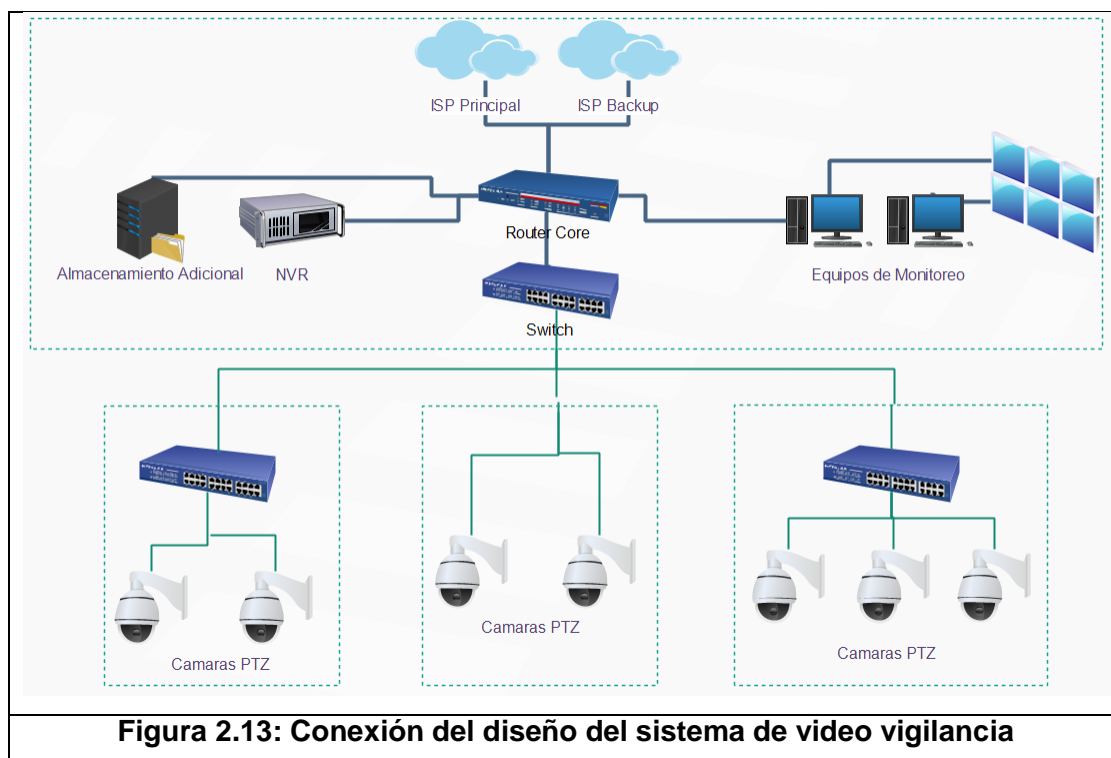

**Figura 2.13: Conexión del diseño del sistema de video vigilancia**

## 2.10 Direccionamiento

En la red del sistema de video vigilancia habrá un total de 61 hosts, para establecer el direccionamiento se utilizará una red clase C debido a que ésta permite manejar hasta 254 hosts dentro del segmento. En la Tabla 13 se puede ver la cantidad específica de casa tipo de equipo.

Equipo	Cantidad
Cámaras	45
Switch	8
PC de monitoreo	4
NVR	2
Servidor de almacenamiento	2
<b>Total</b>	<b>61</b>

**Tabla 13: Cantidad de Dispositivos de red a utilizar**

El diseño de la solución cuenta con 2 centros de monitoreo, cada uno utilizará un segmento de red diferente, el centro de monitoreo A utilizará la red 192.168.1.1 /24 y el centro de monitoreo B utilizará la red 192.168.2.1 /24. En la Tabla 14 y 15 se muestra el detalle de direccionamiento asignado para el Centro de monitoreo A y B respectivamente.

<b>Equipos</b>	<b>IP</b>
Switch Core	192.168.1.1
Switch distribución	192.168.1.2
NVR	192.168.1.3
Servidor de Almacenamiento	192.168.1.4
PC de Monitoreo 1	192.168.1.5
PC de Monitoreo 2	192.168.1.6
Cámaras	192.168.1.7 / 192.168.1.37

**Tabla 14: Direccionamiento del centro de monitoreo A**

<b>Equipos</b>	<b>IP</b>
Switch Core	192.168.2.1
Switch distribución	192.168.2.2
NVR	192.168.2.3
Servidor de Almacenamiento	192.168.2.4
PC de Monitoreo 1	192.168.2.5
PC de Monitoreo 2	192.168.2.6
Cámaras	192.168.2.7 / 192.168.2.37

**Tabla 15: Direccionamiento del centro de monitoreo B**

### 2.11 Seguridad de la red de video vigilancia.

Para evitar el acceso no autorizado de personas ajenas al sistema de video vigilancia se establecerán políticas de acceso como: contraseñas de mínimo 10 caracteres que contengan números y letras diferenciando mayúsculas y minúsculas, los trabajadores deben tener sus credenciales de identificación y que solo personal autorizado tenga acceso a la configuración de los equipos de red.

También se configurarán listas de acceso, las ACLs (Listas de Control de Acceso) permitirán restringir el acceso desde IPs que no están en el rango establecido en el direccionamiento de equipos de red y cámaras de vigilancia.

## CAPÍTULO 3

### 3. GESTIÓN OPERATIVA DE LA SOLUCIÓN.

El sistema de video vigilancia tendrá un costo operativo mensual para mantenerse funcionando. Este valor será cubierto mediante el pago de alcuotas por parte de los habitantes de la primera etapa de la ciudadela Los Vergeles, que se verán beneficiados por el proyecto.

En la ciudadela se establecerá un comité interno, que se encargará de que se cumpla el pago de las alcuotas para mantener activo el sistema de video vigilancia.

#### 3.1 Turnos de trabajo.

Se calculó la cantidad de operadores por turnos de trabajo tomando en cuenta que el centro de monitoreo trabajará 24 horas al día, esto da un total de 21 turnos que se cubrirán a la semana por cada centro de monitoreo.

Un operador cubrirá 5 turnos en la semana y se necesitará tener al menos 2 operadores por turno, dando un total de 16 operadores para los dos centros de monitoreo. El comité de la ciudadela estará a cargo de la organización de los horarios asignados para cada operador.

Se sugiere que los operadores contratados tengan conocimientos técnicos, para que en caso de que exista alguna falla en la red o en los equipos del sistema de video vigilancia el operador de turno pueda solucionarlo en el menor tiempo posible.

Los operadores contarán con todos los beneficios de ley y con las capacitaciones necesarias.

#### 3.2 Alquiler del segundo centro de monitoreo

La vivienda donde se instalará el centro de monitoreo fue puesta a disposición por el dueño con un acuerdo de alquiler. Este contrato se mantendrá de manera indefinida y si en algún momento el dueño del inmueble quiere disponer del piso alquilado lo notificará al comité con al menos 4 meses de anticipación.

Ambos centros de monitoreo contarán con todos los servicios básicos, estos valores serán sumados también a las alícuotas mensuales.

### **3.3 Conexión con el centro de monitoreo**

El centro de monitoreo tendrá conexión con el UPC de la Policía Nacional; cuando se detecte algún hecho delictivo en el centro de monitoreo se llamará vía telefónica al UPC informándoles la ubicación de lo sucedido, de esta forma podrán tomar las medidas respectivas y a su vez ellos avisarán a los habitantes de la ciudadela mediante un mensaje de WhatsApp a los grupos que ellos crearán en esta aplicación.

Se utilizará también la cuenta de correo electrónico [vigilanciavergeles@gmail.com](mailto:vigilanciavergeles@gmail.com) para enviar de manera formal el detalle de lo ocurrido, de esta forma podrá ser utilizado en el proceso legal que iniciará el afectado. Mediante el mismo correo electrónico los habitantes de la ciudadela podrán informar de cualquier novedad que se presente.

### **3.4 Proveedores de internet.**

Los proveedores de internet que se contratarán para el sistema de video vigilancia son:

- Netlife: proveedor de internet principal, con un plan de 20 Mbps, soporte técnico 24/7 y compartición 2:1.
- CNT: como proveedor de respaldo en caso de que el primer proveedor presente inconvenientes, con un plan de 20 Mbps.

### **3.5 Mantenimiento a los equipos**

Para que los equipos como: servidores de visualización, servidores de almacenamiento y NVRs funcionen correctamente es necesario un mantenimiento mensual por parte de los técnicos responsables.

### **3.6 Tabla de los costos operativos**

En la Tabla 16 se detallan los costos operativos que harán posible el funcionamiento del sistema de video vigilancia mensualmente:

<b>Gestión operativa</b>	<b>Valor (\$)</b>	<b>Cantidad(u)</b>	<b>Valor total(\$)</b>
Sueldo a los operadores	\$500.00	16	\$8,000.00
Alquiler del primer centro de monitoreo	\$300.00	1	\$300.00
Servicios de agua potable	\$20.00	2	\$40.00
Servicio de electricidad (kWh)	\$0.09	6228	\$579.20
Servicio telefónico	\$30.00	2	\$60.00
Proveedor principal de internet (Netlife)	\$91.20	1	\$91.20
Proveedor de internet de respaldo (CNT)	\$56.99	1	\$56.99
Mantenimiento de los equipos	\$30.00	8	\$240.00
<b>Total</b>			<b>\$9,367.39</b>

**Tabla 16: Costos operativos**

### **3.7 Plan de pagos para el sistema de video vigilancia.**

El sistema de video vigilancia se podrá mantener activo con un pago mensual de \$9,367.39, valor que será cubierto con el pago de una alícuota mensual de \$10.00 por parte de las familias.

El costo inicial del proyecto será financiado también por los habitantes de la ciudadela, tendrá un valor de implementación de \$144.45 por cada familia, este valor lo podrán pagar en un plazo de 4 meses con una cuota de \$36.11. Una vez que el presupuesto total sea reunido se iniciarán los trabajos para la implementación del sistema de video vigilancia.

## CAPITULO 4

### **4. PLAN DE IMPLEMENTACIÓN Y ESTUDIO ECONÓMICO.**

De acuerdo al desarrollo de la solución propuesta, se describirá el proceso de implementación del diseño del sistema de video vigilancia y el estudio económico de la solución.

Será tomado en cuenta que estarán trabajando 4 personas en la instalación de los dispositivos de red y cámaras de video.

#### **4.1 Instalación de cámaras.**

Según la planificación se determinó el tiempo de instalación de las 45 cámaras de video y la instalación de los switches externos en un total de 11 días.

El primer centro de monitoreo recibirá la conexión de 23 cámaras y el segundo centro de monitoreo recibirá la conexión de las 22 cámaras restantes.

#### **4.2 Cableado**

Para la instalación del cableado FTP(par trenzado con pantalla global) que irán de las cámaras al centro de monitoreo y a los switches externos, se determinó que será realizado en un tiempo de 8 días.

Para la instalación del cable de Fibra óptica desde los switches externos al centro de monitoreo y la conexión entre los centros de monitoreo, se necesitará un tiempo de 6 días.

#### **4.3 Construcción y remodelación del centro de monitoreo.**

Paralelamente a los trabajos de instalación de cámaras en el sector, un contratista externo que encargará de la construcción del segundo centro de monitoreo en un terreno adquirido previamente.

El primer centro de monitoreo se adecuará en el tercer piso de una vivienda, se harán las remodelaciones necesarias para la ubicación de los dispositivos y recursos de red.

Se determinó el tiempo de remodelación y construcción de 10 días.

#### **4.4 Construcción del UPC**

Junto al primer centro de monitoreo se construirá el UPC(unidad de policía comunitaria) , los habitantes de la ciudadela decidieron la donación de un terreno a la Policía Nacional para que el gobierno pueda construir el UPC en el sector.

Este UPC tendrá conexión con el sistema de video vigilancia a través de la red de internet, se le otorgará un usuario y contraseña con el cual puedan ingresar remotamente en caso de que ocurra alguna eventualidad.

#### **4.5 Instalación de los equipos.**

La instalación y ubicación de los equipos de red en los centros de monitoreo se tomará un total de 3 días; durante este tiempo se ubicará un rack principal donde se instalarán: los switches de Core, switches de distribución, el NVR para el almacenamiento de los videos y el servidor para el almacenamiento de eventos específicos. En el segundo rack se instalarán los UPS para el respaldo de energía temporal.

Los televisores estarán ubicados en soportes para pared, frente a ellos se colocarán las estaciones de trabajo con su respectivo servidor para el control de las cámaras.

#### **4.6 Configuración de los equipos.**

Para la configuración de las cámaras, switches, NVRs, servidores de monitoreo y servidores de almacenamiento se tomará un total de 3 días.

En los switches externos y en el switch de distribución de los centros de monitoreo se configurará el estado de las interfaces de red y un pool de direcciones IP en el Servicio DHCP, donde se reservará una determinada dirección IP para cada cámara.

Para que la configuración anterior funcione correctamente las cámaras también deben estar configuradas con el Protocolo DHCP(protocolo de configuración dinámica de host), de esta manera se puede garantizar que cada cámara mantenga una misma IP para evitar conflictos al momento del monitoreo, además se evita la configuración manual de la interfaz de red de cada cámara.

En los servidores de monitoreo que están a cargo de los operadores, se instalará un software especial que permite:

- Registrar las cámaras de la red para poder visualizar la grabación en un televisor, este software permitirá determinar la cantidad de cámaras por pantalla que se visualizará en cada centro de monitoreo.
- Configurar y controlar funciones especiales de las cámaras, como el patrón de movimiento en el acercamiento de imagen de forma remota.

El switch de distribución, los servidores de visualización y los servidores de almacenamiento adicionales estarán conectados directamente al switch Core de la red, este dispositivo es un switch de capa tres que permite tener una gran capacidad de procesamiento de datos y servirá como punto de interconexión entre las cámaras y los NVRs.

Este switch especialmente tendrá funciones de capa tres debido a que es el que provee conexión a internet y entre los centros de monitoreo, en este switch configurarán las políticas de seguridad para evitar el acceso no deseado o ataques a la red.



## 4.7 Diagrama de Gantt

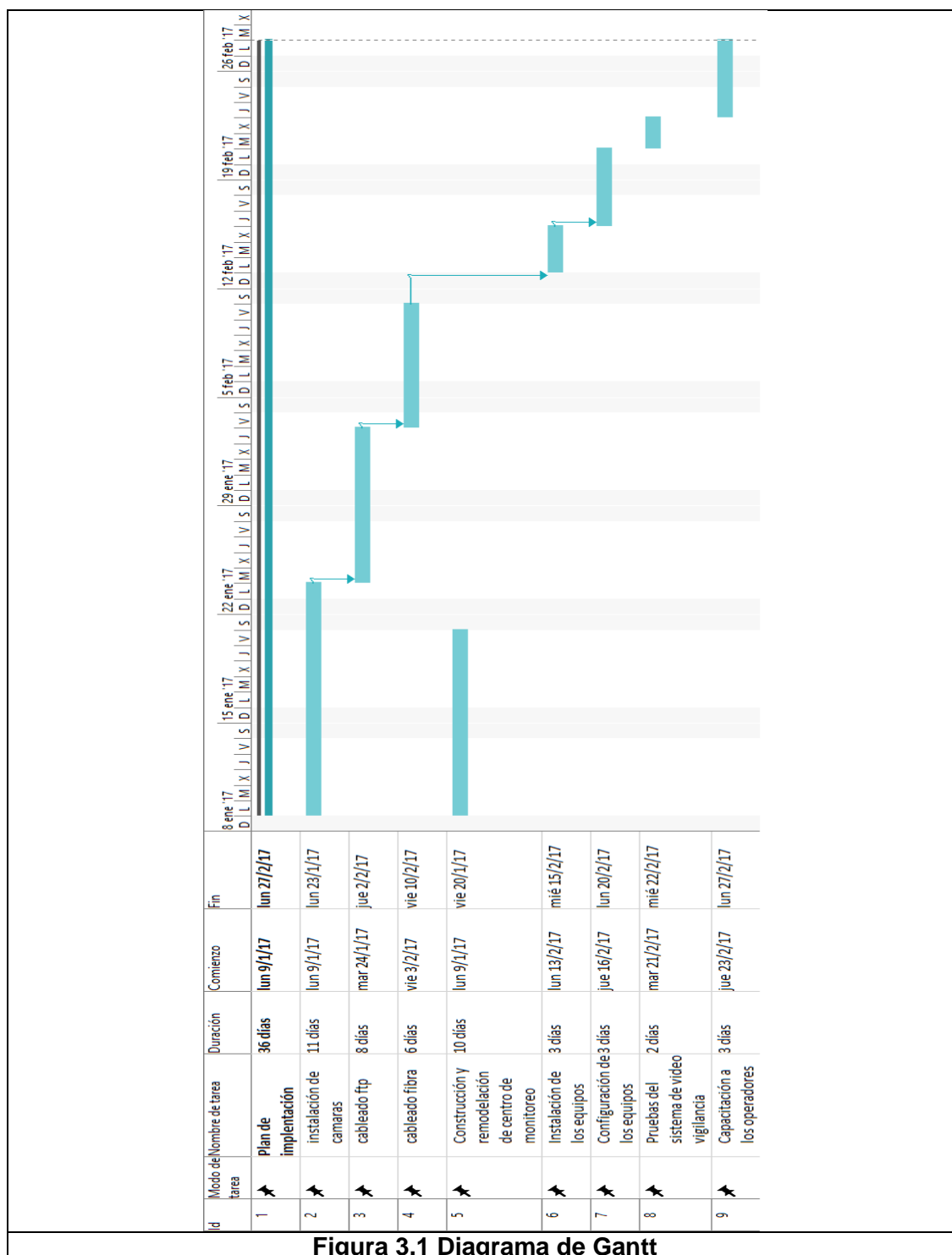

En la Figura 3.1 se detalla en un diagrama de Gantt el cronograma de implementación del diseño de la solución.

#### 4.8 Análisis económico

El presupuesto total para la implementación de la solución es de \$136.586,74 este valor poder ser costado por un aporte inicial de \$144,45 por cada una de las 910 familias que habitan la ciudadela Los Vergeles.

En la Tabla 17 se muestra en detalle el presupuesto para la implementación de la solución escogida.

Producto	Cantidad (u)	Valor unitario (\$)	Valor total (\$)
Terreno	1	\$12,500.00	\$12,500.00
Remodelación del segundo centro de monitoreo	1	\$1,000.00	\$1,000.00
Construcción del segundo centro de monitoreo	1	\$4,000.00	\$4,000.00
Acondicionador de aire	2	\$850.00	\$1,700.00
Escritorios	4	\$70.00	\$280.00
Televisores	4	\$800.00	\$3,200.00
Sillas	4	\$35.00	\$140.00
Teléfono convencional	2	\$30.00	\$60.00
Racks	2	\$1,075.25	\$2,150.50
Servidores de almacenamiento	2	\$565.00	\$1,130.00
Servidores de visualización	2	\$1,200.00	\$2,400.00
NVR	2	\$1,800.00	\$3,600.00
UPS	2	\$1,911.00	\$3,822.00
Switch 3850 Core 24 puertos	2	\$14,800.00	\$29,600.00
Switch 3560 Distribución 24 puertos	2	\$1,872.00	\$3,744.00
Switch 3560 8 puertos	3	\$1,132.00	\$3,396.00
Switch 3560 12 puertos	1	\$1,249.00	\$1,249.00
Cámaras PTZ DS-2D65174-AE	45	\$955.00	\$42,975.00
Cajetín para switch	4	\$110.00	\$440.00
Cajetín para extensión	10	\$52.00	\$520.00
Soporte para cámaras	4	\$20.00	\$80.00
Cable FTP Panduit 6A (rollos 300mts)	16	\$525.00	\$8,400.00
Fibra óptica multimodo (mts)	1235	\$2.00	\$2,470.00
Patch Core	88	\$4.38	\$385.44
Patch Panel Nexxt 24 puertos	2	\$82.00	\$164.00
Patch Panel Nexxt 16 puertos	2	\$63.00	\$126.00
Conectores Rj45	160	\$0.53	\$84.80
Cable HDMI	4	\$12.00	\$48.00
Extensión Startech	10	\$178.00	\$1,780.00
<b>Total</b>			<b>\$131,444.74</b>

**Tabla 17: Presupuesto del diseño de video vigilancia**

## CONCLUSIONES Y RECOMENDACIONES

Con este proyecto se ayudará a reducir el número de delitos que ocurren en la ciudadela Los Vergeles. Los habitantes se sentirán más seguros al reportar un delito manteniendo el anonimato.

Para que el sistema de video vigilancia tenga un excelente desempeño se determinó que la conexión externa de las cámaras sea por medio de cable en lugar de wifi debido a que la tecnología inalámbrica de la ciudadela sufriría de mucha interferencia y también de las redes inalámbricas que están presente en los domicilios de los habitantes.

El sistema de video vigilancia cuenta con políticas de seguridad y control de acceso que protegen la información de terceras personas, así se garantizará que las grabaciones no sean utilizadas con fines que puedan afectar la seguridad de los habitantes.

Para elección del modelo de cámara se tomó en cuenta los aspectos más importantes para los habitantes de la ciudadela como son la calidad de imagen y la distancia que debe cubrir cada cámara, por esta razón se eligió las cámaras con capacidad de movimiento que se adaptaron a todas las circunstancias que se presentaron durante el diseño de la solución.

Para evitar que los equipos de red presenten daños o un mal funcionamiento se debe programar el mantenimiento de los mismos cada 6 meses.

Las personas que operen en el centro de monitoreo deben estar capacitados para su óptimo funcionamiento.

Se debe dar un mantenimiento después de 1 año a las cámaras de video vigilancia.

Se debe crear políticas de seguridad como claves, para el acceso a la información de los servidores.

## BIBLIOGRAFÍA

- [1] H. M Deitel, Sistemas Operativos, 2<sup>nd</sup> Ed. Addison Wesley, Iberoamericana S.A., 1993.
- [2] Radio-enlace, (2016, agosto). Tipos de Fibra [online]. Disponible en:  
<http://www.radio-enlace.com/tipos-de-fibra-om1-om2-om3-om4-om5-os1-os2/>
- [3] Cisco System, Inc. Cisco IOS Network Security, Macmillan Technical Publishing. 1998.
- [4] Mc Graw – Hill, Manual de Seguridad para PC y Redes Locales, Iberoamericana de España S. A. 1994
- [5] Everac99, (2016, agosto), Alta Disponibilidad [online]. Disponible en:  
<https://everac99.wordpress.com/2008/08/19/alta-disponibilidad-que-es-y-como-se-logra/>
- [6] Douglas E. Comer , Redes de Computadoras Internet e Interredes, 2<sup>era</sup> Edición, Prentice – Hall Hispanoamericana S.A. . 1997
- [7] UPS, (2016, agosto), Modelo de UPS [online]. Disponible en:  
<http://www.ups-online.com.ar/apc/apc-smart-ups-on-line/apc-surt8000xli>.
- [8] Hikvision, Características de NVRs [online]. Disponible en:  
[http://www.hikvisionecuador.com/assets/catalogo\\_hikvision2.pdf](http://www.hikvisionecuador.com/assets/catalogo_hikvision2.pdf)

# ANEXOS

# **DATASHEET DE EXTENSOR PoE STARTECH**

## Extensor PoE+ Gigabit 802.3at/af - 100m

StarTech ID: POEEXT1GAT



Este extensor Gigabit PoE+ amplía el alcance de un dispositivo con alimentación PoE a una mayor distancia, al doble del límite de 100 metros que permite una infraestructura PoE convencional.



Ahora es posible conectar un dispositivo Gigabit PoE a hasta 200 metros de distancia máxima, lo cual facilita la instalación de un punto de acceso o una cámara IP remota. Además, el extensor se puede conectar en serie para mayor escalabilidad.

### Rango de alcance PoE+ sin límite, que resulta más práctico

¿Necesita un mayor alcance? Este práctico repetidor PoE+ ofrece el mayor alcance y flexibilidad, ya que permite extender una conexión PoE 100m adicionales, a la vez que ofrece una potencia de salida de 24W a dispositivos compatibles.

Basta con conectar el extensor a su equipo de alimentación de entrada (PSE) y al dispositivo alimentado por PoE y ¡listo! El extensor es compatible con la norma 802.3at/af, lo cual significa que funciona con un equipo de alimentación de entrada (PSE), como el inyector PoE+ (POEINJ1G) o el conmutador PoE+ (IES81000POE) de StarTech.com.

### Conexión en serie para mayor distancia y flexibilidad

¿Necesita un alcance aún mayor? Si 100 metros extra no son suficientes, este extensor PoE con todas las funciones y características posibles ofrece también la opción de conexiones en serie.

Es muy fácil la conexión conjunta de cuatro extensores, lo cual significa que se pueden instalar los dispositivos alimentados por PoE+ a una distancia de hasta 500m. Solución perfecta para empresas, instituciones académicas o tiendas de venta al por mayor (la potencia de salida depende del número de extensores conectados en serie que se utilicen).

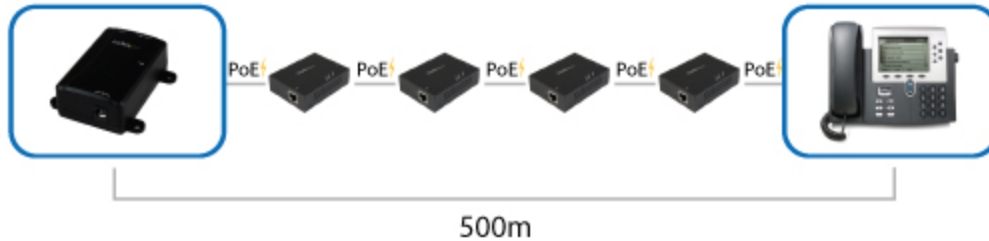

## Prácticas opciones de instalación y duradera fabricación

Con una configuración e instalación rápida. Este extensor Gigabit PoE+ se puede colocar donde sea necesario, ya que su diseño de montaje en pared no requiere un adaptador de alimentación externo.

Puede disfrutar de un rendimiento fiable, sin preocuparse por interrupciones o fallas del funcionamiento, ya que el extensor tiene una duradera caja de metal con protección contra descargas electrostáticas (ESD) y sobrecargas.

El modelo POEEXT1GAT está avalado por la garantía de 2 años de StarTech.com y con soporte técnico gratuito de por vida.

### Applications

- Ideal para puntos de acceso inalámbrico Wi-Fi®, teléfonos por IP, cámaras de vigilancia y quioscos para los que no existe una conexión de alimentación disponible
- Habilite la instalación remota de dispositivos con alimentación por PoE+ a una mayor distancia que lo que permite PoE convencional
- Solución perfecta para usuarios SOHO (pequeña oficina/oficina en casa), PYMEs , integradores de sistemas y administradores informáticos



## Features

- Coloque y acceda a sus dispositivos alimentados (PD) por Gigabit PoE a una distancia mayor
- Amplíe la distancia de sus dispositivos alimentados (PD) por PoE mediante la conexión en serie de cuatro extensores, en hasta 500 metros en total (salida de potencia reducida en cada conexión)
- Caja compacta, para montaje en pared, de metal resistente, a fin de ofrecer confiabilidad y uso práctico
- Protección contra sobretensión y contra descargas electrostáticas (ESD) 2kV
- Configuración plug-and-play, que no requiere adaptador de alimentación
- Entrada IEEE 802.3at a 30W a salida IEEE 802.3at/af a 24W
- Tensión de salida de 52V a 56V
- Detección automática de su dispositivo alimentado (PD), a fin de evitar daños en caso de una instalación incorrecta.

**Technical Specifications**

Warranty	2 Years
Cantidad de Puertos	1
Estándares Industriales	IEEE 802.3af PoE, IEEE 802.3at PoE+
Estándares Industriales	IEEE 802.3 10BASE-T, IEEE 802.3u 100BASE-TX, IEEE 802.3ab 1000BASE-T
Arquitectura de Conmutación	Almacenar-y-Enviar
Auto negociación	Sí
Control de Flujo	IEEE 802.3x: contrapresión de dúplex medio y trama de pausa para dúplex completo
Especificaciones Generales	Un extensor - Potencia de salida a 24W : Dos extensores por conexión en serie - Potencia de salida a 20W : Tres extensores por conexión en serie - Potencia de salida a 16W : Cuatro extensores por conexión en serie - 12W
Jumbo Frame Support	No
Longitud Máxima del Cable	328 ft [100 m]
MDIX Automático	Sí
MTBF	50.000 horas
Protección Contra Sobretensión	EN61000-4-2 (carga electrostática) - 2kV EN61000-4-5 (sobretensión) - 2kV
Redes Compatibles	10/100/1000 Mbps
Soporte Full Duplex	Sí
Tasa de Transferencia de Datos Máxima	2 Gbps (dúplex completo)
Tipo(s) de Conector(es)	2 - RJ-45 Hembra
Nota	La distancia total de extensión puede resultar a menudo más corta debido a la caída de tensión en los cables conectados. Las distancias máximas pueden variar según la calidad de los cables UTP y el entorno.

Nota	Puede conectar en serie hasta un total de 4 unidades POEEXT1GAT, para alcanzar un máximo de 500 metros. La cuarta unidad proveerá el suministro a IEEE 802.3af con una potencia de salida de hasta 12W.
Patents and Licenses	The following patents are licensed for this product. This list might not be all inclusive. <ul style="list-style-type: none"> <li>• United States Patent No. 5,406,260 (expired)</li> <li>• United States Patent No. 6,650,622</li> <li>• United States Patent No. 7,457,250</li> <li>• United States Patent No. 8,155,012</li> <li>• United States Patent No. 8,902,760</li> <li>• United States Patent No. 8,942,107</li> <li>• United States Patent No. 9,019,838</li> <li>• United States Patent No. 9,049,019</li> <li>• United States Patent Application No. 14/695,456</li> <li>• United States Patent Application No. 14/726,940</li> </ul>
Requerimientos del Sistema y Cables	Si su dispositivo conectado no cumple con las normas IEEE 802.3af o IEEE 802.3at PoE, el dispositivo POEEXT1GAT no suministrará alimentación al dispositivo conectado / cable Ethernet
Indicadores LED	1 - PoE IN (ENTRADA PoE)
Indicadores LED	1 - LNK/ACT (ENLACE/ACTIVIDAD)
Indicadores LED	1 - PoE OUT (SALIDA PoE)
Adaptador de Corriente Incluido	Alimentación por Ethernet (PoE)
Consumo de Energía	3.2 W Max
Tensión de Salida	52 ~ 56 DC
Humedad	HR 5~95% (sin condensación)
Temperatura de Almacenamiento	-10°C to 85°C (14°F to 185°F)
Temperatura Operativa	0°C to 50°C (32°F to 122°F)
Altura del Producto	1 in [25 mm]
Ancho del Producto	2.7 in [69 mm]
Color	Negro
Longitud del Producto	3.7 in [94 mm]
Peso del Producto	6.6 oz [188 g]

Tipo de Gabinete Acero

Peso (de la Caja) 12 oz [339 g]  
del Envío

Incluido en la Caja 1 - Extensor Gigabit de alimentación PoE

Incluido en la Caja 1 - Manual de Instrucciones

**Certifications, Reports and Compatibility**



# **DATASHEET SWITCH CISCO 3560 CX**

# Cisco Catalyst 3560-CX and 2960-CX Series Compact Switches

The Cisco® Catalyst® Compact Switches easily expand your Ethernet and Multigigabit Ethernet Cisco Catalyst switching infrastructure outside the wiring closet to enable new workspaces, extend wireless LANs, and connect PoE devices. These fanless, small form-factor switches are ideal for space-constrained deployments where multiple cable runs would be challenging. With speeds that reach 10Gbps, the Cisco Catalyst 3560CX Multigigabit Ethernet Switches support current and next-generation wireless speeds and standards (including 802.11ac Wave 2) on existing cabling infrastructure.

## Product Overview

The Cisco Catalyst 3560-CX and 2960-CX Series Compact Switches help optimize network deployments. These Gigabit Ethernet (GbE) and Multigigabit Ethernet (mGig) managed switches are ideal for high-speed data connectivity, Wi-Fi backhaul, and Power over Ethernet (PoE+) connectivity in places where space is at a premium. With a single copper or fiber cable from the wiring closet, Cisco Catalyst compact switches enable IP connectivity for devices such as IP phones, wireless access points, surveillance cameras, PCs, and video endpoints.

With their quiet, fanless design and compact footprint, these switches offer flexible mounting options and open up a variety of network design and connectivity options. Use them in offices, classrooms, hotels, retail stores, and other enterprise and branch locations. The setup allows for shorter cable runs from the compact switches, allowing for flexibility in space redesign and growth as new devices join the network - this eliminating the need for expensive and inflexible cabling infrastructure.

## Cisco Catalyst 3560-CX and 2960-CX Series Compact Switch Highlights

- 8 or 12 Gigabit Ethernet ports with line rate forwarding performance
- 6 Gigabit Ethernet plus 2 Multigigabit Ethernet (100 Mbps/1/2.5/5/10 Gbps) ports with line rate forwarding performance (selected model)
- Gigabit and Multigigabit (100 Mbps/1/2.5/5/10 Gbps) copper, small form-factor pluggable (SFP) or 10G SFP+ uplinks
- Power over Ethernet Plus (PoE+) support with up to 240W of PoE budget
- Power over Ethernet (PoE) pass-through enables the compact switch to draw Cisco Universal PoE (Cisco UPOE™) power from the wiring closet and pass it to end devices (selected model) with the additional option to be powered by auxiliary AC-DC or DC-DC power adapter
- Cisco Instant Access mode to enable single point of management and simplify operation (selected models)
- Advanced Layer 2 (LAN Base) and Layer 3 (IP Base) support with an option to upgrade to IP services
- Fanless design and silent operation
- Enhanced Limited Lifetime Warranty (E-LLW)

Figure 1 shows the Cisco Catalyst 3560-CX and 2960-CX switch family.

**Figure 1.** Cisco Catalyst 3560-CX and 2960-CX Compact Switch Family



## Features and Benefits

Like the larger Cisco Catalyst switches typically used in wiring closets, the Cisco Catalyst Compact switches are a managed option for consistency across your LAN switching network. Unlike unmanaged switches and hubs, they provide advanced networking features for flexibility, security, and scale.

Table 1 lists many of the Cisco Catalyst 3560-CX and 2960-CX switch features and benefits.

**Table 1.** Compact Switch Features and Benefits Summary

Feature	Benefits
<b>Hardware</b>	
<b>Small form factor; fanless design; silent operation</b>	The switch can be used in open workspaces and other areas that cannot tolerate equipment noise and where multiple cable runs could be difficult, expensive, and intrusive.
<b>Flexible mounting options</b>	The switch can be mounted on the wall, under a desk, rack, DIN rail, or practically anywhere they are needed.
<b>Cisco Multigigabit Ethernet</b>	<p>With the enormous growth of 802.11ac and new wireless applications, wireless devices are driving the demand for more network bandwidth. This creates a need for a technology that supports speeds higher than 1 Gbps on all cabling infrastructure. Cisco Multigigabit Ethernet technology is a unique Cisco innovation that allows you to achieve bandwidth between speeds of 100Mbps and 10 Gbps over traditional Cat 5e cabling or above. In addition, the Multigigabit ports on the Cisco Catalyst Compact switch support PoE+, which is increasingly important for next-generation workspaces and Internet of Things (IoT) ecosystems. The Multigigabit Ethernet ports can also be used as uplinks to connect to traditional access switches such as the Cisco Catalyst 3850/4500 switches.</p> <p>Cisco Multigigabit technology offers significant benefits for a diverse range of speeds, cable types, and PoE power. The benefits can be grouped into three different areas:</p> <ul style="list-style-type: none"> <li>• <b>Multiple speeds:</b> Cisco Multigigabit technology supports autonegotiation of multiple speeds on switch ports. The supported speeds are 100 Mbps, 1 Gbps, 2.5 Gbps, and 5 Gbps on Cat 5e cable and up to 10 Gbps over Cat 6a cabling.</li> <li>• <b>Cable type:</b> The technology supports a wide range of cable types, including Cat 5e, Cat 6, and Cat 6a or above.</li> <li>• <b>PoE power:</b> The technology supports PoE and PoE+ for all the supported speeds and cable types.</li> </ul>
<b>10-Gigabit SFP+ uplinks</b>	Accommodates business growth and increased traffic, such as aggregate upstream gigabit traffic loads from 802.11ac Wi-Fi access points.
<b>Increased PoE+ Scale</b>	Provides up to 240W of PoE+ budget (twice the power per switch than previous series).
<b>Perpetual PoE</b>	Provides uninterrupted power to a powered-down device even when the switch is booting. This eliminates the need for a backup power source.
<b>PoE pass-through</b>	<b>PoE pass-through</b> gives the ability to power PoE end devices through drawing Cisco UPOE from the wiring closet. The Cisco Catalyst WS-C3560CX-8PT-S has eight downlink ports with two Cisco UPOE input ports that allow it to be powered by another switch. These switches do not need a power supply and receive power over the uplink from an upstream PoE or Cisco UPOE device, providing deployment flexibility and availability. These switches are ideal for wiring-constrained and space-constrained applications.

Feature	Benefits
<b>Management and Operations</b>	
<a href="#">Cisco Instant Access Mode</a>	<p>Available on Cisco Catalyst 3560-CX switches with 10 G SFP+ uplinks, this optional mode enables a single point of management and operation for campus networks. Multiple Cisco Catalyst 3560-CX compact switches with 10 G SFP+ uplinks can be connected to Cisco Catalyst 6500 or 6800 core switches, and the entire configuration can then work as a single extended switch with a common management domain.</p> <p>In this mode, compact switches inherit all the features of the Cisco Catalyst 6500 or 6800. Advanced Cisco Catalyst 6500 and 6800 features like MPLS and EVN can be extended to the access layer, so the Cisco Catalyst Instant Access solution can be deployed on all or a subset of the campus network.</p>
<b>Cisco Network Plug 'n Play (PnP)</b>	<p>Network Plug-n-Play (PnP) is a secure, scalable solution that accelerates network device deployments by automating the installation and configuration of Cisco IOS software. The Cisco Catalyst 3560-CX and 2960-CX switches are 'Network-PnP Ready' and can be used as part of the APIC-EM solution for automated switch deployments. This feature helps improve productivity, cut costs, reduce downtime, and enhance the user experience.</p>
<a href="#">Cisco Catalyst Smart Operations</a>	<p>This comprehensive set of Cisco Catalyst technologies and Cisco IOS Software features simplify LAN deployment, configuration, and troubleshooting.</p> <ul style="list-style-type: none"> <li>• <b>Cisco Smart Install</b> enables the configuration of the Cisco IOS Software image and switch without user intervention.</li> <li>• <b>Cisco Auto Smartports</b> provides automatic configuration as end devices connect to the switch port, allowing autodetection and plug-and-play of the device onto the network. Interface templates containing configurations or policies that can be applied to ports are also supported.</li> <li>• <b>Cisco Smart Troubleshooting</b> is an extensive array of debug diagnostic commands and system health checks, including <b>Generic Online Diagnostics (GOLD)</b> and <b>Onboard Failure Logging (OBFL)</b>.</li> <li>• <b>Embedded Event Manager (EEM)</b>, supported on the Cisco Catalyst 3560-CX, provides real-time network event detection and onboard automation. You can adapt the behavior of your network devices to align with business needs.</li> </ul>
<b>Cloud and System Management</b>	<ul style="list-style-type: none"> <li>• <b>Cisco Prime™ Infrastructure</b> provides comprehensive network lifecycle management with an extensive library of features that automate initial and day-to-day management. Cisco Prime integrates hardware and software platform expertise and operational experience into a powerful set of workflow-driven configuration, monitoring, troubleshooting, reporting, and administrative tools.</li> <li>• <b>Cisco Network Assistant</b> is a PC-based, centralized network management and configuration application for small and medium-sized business (SMB) with up to 250 users. An intuitive GUI lets you easily apply common services across Cisco switches, routers, and access points.</li> <li>• <b>Cisco Active Advisor</b> is a cloud-based service that provides essential lifecycle information about your network inventory. Available by itself or as a component of other Cisco network management applications, it helps you reduce your network's overall risk by keeping you up-to-date on the status of your products.</li> </ul>
<b>Operational Simplicity</b>	<ul style="list-style-type: none"> <li>• <b>Link Aggregation Control Protocol (LACP)</b> for creating Ethernet channeling with devices that conform to IEEE 802.3ad. Similar to Cisco EtherChannel technology and PAgP.</li> <li>• <b>Dynamic Host Configuration Protocol (DHCP)</b> autoconfiguration of multiple switches through a boot server.</li> <li>• <b>Multicast VLAN Registration (MVR)</b> continuously sends multicast streams in a multicast VLAN. Isolates streams from subscriber VLANs for bandwidth and security reasons.</li> <li>• <b>Voice VLAN</b> keeps voice traffic on a separate VLAN for easier administration and troubleshooting.</li> <li>• <b>Cisco VLAN Trunking Protocol (VTP)</b> supports dynamic VLANs and dynamic trunk configuration across all switches.</li> <li>• <b>Remote Switch Port Analyzer (RSPAN)</b> allows administrators to remotely monitor ports in a Layer 2 switch network from any other switch in the same network.</li> <li>• For enhanced traffic management, monitoring, and analysis, the Embedded <b>Remote Monitoring (RMON)</b> software agent supports four RMON groups (history, statistics, alarms, and events).</li> </ul>
<b>Security</b>	
<a href="#">Cisco TrustSec®</a>	<p>A suite of components that secures networks, data, and resources with policy-based access control, identity, and role-aware networking with the following elements:</p> <ul style="list-style-type: none"> <li>• <b>Cisco TrustSec SXP</b> support to simplify security and policy enforcement throughout the network. For more information about Cisco TrustSec security solutions, visit <a href="http://cisco.com/go/TrustSec">cisco.com/go/TrustSec</a>.</li> <li>• <b>Hardware on the Cisco Catalyst 3560-CX for IEEE 802.1AE MACsec</b> for Layer 2, line-rate Ethernet data confidentiality and integrity on host-facing ports. Protects against man-in-the-middle attacks (snooping, tampering, and replay).</li> <li>• Flexible authentication that supports multiple authentication mechanisms including <b>802.1X</b>, <b>MAC Authentication Bypass</b>, and <b>web authentication</b> using a single, consistent configuration.</li> <li>• <b>Monitor mode</b> that creates a user-friendly environment for 802.1X operations.</li> <li>• <b>RADIUS change of authorization and downloadable ACLs</b> for comprehensive policy management.</li> <li>• <b>802.1X supplicant with Network Edge Access Transport (NEAT)</b> for extended secure access; compact switches in the conference rooms have the same level of security as switches inside a locked wiring closet.</li> </ul>



Feature	Benefits
<b>Threat Defense</b>	<p>Advanced, integrated security features that provide threat defense capabilities for mitigating man-in-the-middle attacks and protecting your critical network infrastructure.</p> <ul style="list-style-type: none"> <li>• <b>Superior Layer 2 capabilities</b> for mitigating MAC, IP, and ARP spoofing risks. Also protects port security, guards against DHCP snooping, and supports Dynamic ARP Inspection and IP Source Guard.</li> <li>• <b>Ipv6 first-hop security</b> with Binding Integrity Guard, RA Guard, and DHCP Guard.</li> <li>• <b>Private VLAN</b> provides security and isolation between switch ports.</li> <li>• <b>Multidomain Authentication</b> allows an IP phone and a PC to authenticate on the same switch port while placing them on appropriate voice and data VLAN.</li> <li>• <b>Secure Shell (SSH), Kerberos, and Simple Network Management Protocol Version 3 (SNMPv3) that encrypt</b> administrator traffic during Telnet and SNMP sessions to keep access credentials secure.</li> <li>• <b>Port-based access control list (ACL)</b> to let the switch automatically allow or block packets based on policies for source and destination IP addresses. Rules can be set up differently on a port-by-port basis.</li> <li>• <b>Secure Boot</b> to make sure that only signed and authorized images can load on the switch.</li> <li>• <b>Cisco AutoSecure</b> to simplify security configurations with a single-line CLI.</li> </ul>
<b>Power Management and Energy Efficiency</b>	
<b>Switch Hibernate Mode</b>	Innovative technology that puts the switch in an ultra-low power mode during periods of nonoperation such as nights and weekends. The switch can be configured to be in the hibernate mode using the Cisco Energy Management Suite.
<b>IEEE 802.3az or Energy-Efficient Ethernet (EEE)</b>	Ports dynamically sense idle periods between traffic bursts and quickly switch the interfaces into a low-power idle mode, reducing power consumption.
<b>Perpetual PoE</b>	Provides uninterrupted power to a powered-down device even when the switch is booting. This eliminates the need for a backup power source.
<b>PoE pass-through</b>	<b>PoE pass-through</b> gives the ability to power PoE end devices through drawing Cisco UPOE from the wiring closet. The Cisco Catalyst 3560CX-8PT-S has eight downlink ports with two Cisco UPOE input ports that allow it to be powered by another switch. These switches do not need a power supply and receive power over the uplink from an upstream PoE or Cisco UPOE device, providing deployment flexibility and availability.
<b>Cisco Energy Management Suite (formerly EnergyWise)</b>	Measures power consumption of network infrastructure and network-attached devices and enforces rules to reduce energy usage.
<b>Power Supply</b>	80-Plus Silver Certified
<b>Traffic Management and QoS</b>	
<b>Application Visibility</b>	<a href="#">NetFlow Lite</a> lets you maintain awareness of all application traffic on the network. It helps capture and record specific packet flows. Exports flow data in the NetFlow Version 9 format for analysis on a wide range of Cisco and third-party collectors.
<b>Advanced Quality of Service</b>	<p>Intelligent traffic management with flexible mechanisms for marking, classifying, and scheduling traffic at wire speed. Includes:</p> <ul style="list-style-type: none"> <li>• Up to <b>eight egress queues</b> per port and strict priority queuing so that the highest priority packets are serviced ahead of all other traffic.</li> <li>• <b>Shaped Round Robin (SRR)</b> scheduling and <b>Weighted Tail Drop (WTD)</b> congestion avoidance.</li> <li>• <b>Flow-based rate limiting</b> and up to 256 aggregate or individual policers per port.</li> </ul>

## Product Details

### Switch Models

The Cisco Catalyst Compact Switches are available in nine switch models. They vary by whether they support both Layer 2 and Layer 3 services or Layer 2 services only; whether they support Power over Ethernet Plus (PoE+); by the number of Gigabit Ethernet and Multigigabit Ethernet ports; the aggregate power provided, and the type of cabling connections they support.

Tables 2, 3, and 4 compare the available switch models and list the software package that ships by default with each model and how much PoE power is available for the downlink ports.

**Table 2.** Cisco Catalyst 3560-X Compact Switch Models and Default Software

Model	Ethernet Ports	PoE Output Ports	Available PoE Power	Uplinks	Default Software
<b>3560CX-8TC-S</b>	8 x 10/100/1000 Gigabit Ethernet	NA		2 x 1G copper plus 2 x 1G SFP	IP Base (IP Services with RTU License)
<b>3560CX-12TC-S</b>	12 x 10/100/1000 Gigabit Ethernet	NA		2 x 1G copper plus 2 x 1G SFP	IP Base (IP Services with RTU License)
<b>3560CX-8PC-S</b>	8 x 10/100/1000 Gigabit Ethernet	8 PoE+	240W	2 x 1G copper plus 2 x 1G SFP	IP Base (IP Services with RTU License)
<b>3560CX-12PC-S</b>	12 x 10/100/1000 Gigabit Ethernet	12 PoE+	240W	2 x 1G copper plus 2 x 1G SFP	IP Base (IP Services with RTU License)
<b>3560CX-12PD-S</b>	12 x 10/100/1000 Gigabit Ethernet	12 PoE+	240W	2 x 1G copper plus 2 x 10G SFP+	IP Base (IP Services with RTU License)
<b>C3560CX-8PT-S</b>	8 x 10/100/1000 Gigabit Ethernet	8 PoE+	Up to 146W	2 x 1G copper (Cisco UPOE+ uplinks)	IP Base (IP Services with RTU License)
<b>C3560CX-8XPD-S</b>	6 x 10/100/1000 Gigabit Ethernet plus 2 Multigigabit Ethernet 100/2500/5000/10000	8 PoE+	240W	2 x 10G SFP+	IP Base (IP Services with RTU License)

**Table 3.** C3560CX-8PT-S Switch PoE and PoE+ Power Capacity

Model	Powering Option	Available PoE Power (W)	Can Switch Be Powered with Uplinks?
<b>3560CX-8TC-S</b>	Internal power supply	0W	No
<b>3560CX-12TC-S</b>	Internal power supply	0W	No
<b>3560CX-8PC-S</b>	Internal power supply	240W	No
<b>3560CX-12PC-S</b>	Internal power supply	240W	No
<b>3560CX-12PD-S</b>	Internal power supply	240W	No
<b>C3560CX-8PT-S</b>	1 PoE uplink	0W	No
	2 PoE uplinks	0W	Yes
	1 PoE+ uplink	0W	Yes
	2 PoE+ uplinks	20W	Yes
	1 Cisco UPOE uplink	22W	Yes
	2 Cisco UPOE uplinks	68W	Yes
	Auxiliary input	54W	Yes
	1 PoE uplink plus auxiliary input	65W	Yes
	2 PoE uplinks plus auxiliary input	76W	Yes
	1 PoE+ uplink plus auxiliary input	76W	Yes
	2 PoE+ uplinks plus auxiliary input	98W	Yes
	1 Cisco UPOE uplink plus auxiliary input	100W	Yes
	2 Cisco UPOE uplinks plus auxiliary input	146W	Yes
	<b>3560CX-8XPD-S</b>	Internal power supply	240W

**Table 4.** Cisco Catalyst 2960-X Compact Switch Models and Default Software

Model	Ethernet Ports	PoE Output Ports	Available PoE Power	Uplinks	Default Software
2960CX-8TC-L	8 x 10/100/1000 Gigabit Ethernet	N/A		2 x 1G copper plus 2 x 1G SFP	LAN Base
2960CX-8PC-L	8 x 10/100/1000 Gigabit Ethernet	8 PoE+	124W	2 x 1G copper plus 2 x 1G SFP	LAN Base

**Note:** All four uplink ports (two copper and two fiber) can be used simultaneously and also as downlinks.

### Switch Software

Cisco Catalyst 3560-CX compact switches ship with the IP Base version of Cisco IOS® Software. The 3560-CX switches can be upgraded to use the IP Services version of IOS Software with a right-to-use (RTU) License. The IP Base and IP Services feature set on Cisco Catalyst 3560-CX switches provides baseline enterprise services in addition to all LAN Base features. They support Layer 3 networking features, including support for routed access, Cisco TrustSec, media access control security (MACsec), and other advanced network services. The IP Services feature set provides full Layer 3 routing capabilities with Open Shortest Path First (OSPF), Border Gateway Protocol (BGP), Enhanced Internal Gateway Routing Protocol (EIGRP), Policy-Based Routing (PBR), Multicast Routing, and Virtual Routing and Forwarding (VRF) Lite.

Cisco Catalyst 2960-CX Series compact switches ship with the LAN Base version of Cisco IOS Software. These switches deliver advanced Layer 2 switching with intelligent Layer 2 through 4 services for the network edge, such as voice, video, and wireless LAN services.

### Licensing and Software Policy

Customers with Cisco Catalyst LAN Base and IP Base software feature sets will receive updates and bug fixes designed to maintain the compliance of the software with published specifications, release notes, and industry standards compliance as long as the original end user continues to own or use the product or for up to one year from the end-of-sale date for this product, whichever occurs earlier. This policy supersedes any previous warranty or software statement and is subject to change without notice.

### Product Specifications

Table 5 provides hardware specifications for the Cisco Catalyst 3560-CX and 2960-CX compact switches.

**Table 5.** Cisco Catalyst 3560-CX and 2960-CX Series Compact Switch Hardware

Description	Specification		
	Cisco Catalyst 3560-CX	Cisco Catalyst 2960-CX	
Performance	Forwarding Bandwidth	46 Gbps (with C3560CX-8XPD-S) 34 Gbps (with C3560CX-12PD-S) 16 Gbps (with 1 G uplinks)	12 Gbps
	Switching Bandwidth (full-duplex capacity)	92 Gbps (with C3560CX-8XPD-S) 68 Gbps (with C3560CX-12PD-S) 32 Gbps (with 1 G uplinks)	24 Gbps
	Flash memory	128 MB	128 MB
	Memory DRAM	512 MB	512 MB
	Max VLANs	1023	255
	VLAN IDs	4000	4000

Description	Specification		
	Maximum transmission unit (MTU)	Up to 9000 bytes	Up to 9000 bytes
	Jumbo frames	9198 bytes	9198 bytes
	<b>Forwarding rate 64 Byte Packet Cisco Catalyst 3560-CX and 2960-CX</b>		
	2960CX-8TC-L	17.9 mpps	
	2960CX-8PC-L	17.9 mpps	
	3560CX-8TC-S	17.9 mpps	
	3560CX-12TC-S	23.8 mpps	
	3560CX-8PC-S	17.9 mpps	
	3560CX-12PC-S	23.8 mpps	
	3560CX-12PD-S	50.6 mpps	
	3560CX-8PT-S	14.9 mpps	
	3560CX-8XPD-S	68.4 mpps	
	<b>Resource Cisco Catalyst 3560-CX and 2960-CX</b>		
	See the release notes for the SDM Templates for 3560-CX and 2960-CX: <a href="http://www.cisco.com/c/en/us/td/docs/switches/lan/catalyst2960cx_3650cx/software/release/15-2_3_e/release_notes/rn-1523e-2960cx-3560cx.html">http://www.cisco.com/c/en/us/td/docs/switches/lan/catalyst2960cx_3650cx/software/release/15-2_3_e/release_notes/rn-1523e-2960cx-3560cx.html</a>		
<b>Connectors and cabling</b>	<b>Cisco Catalyst 3560-CX and 2960-CX Ethernet Interfaces:</b> <ul style="list-style-type: none"> <li>• 10BASE-T ports: RJ-45 connectors, 2-pair Category 3, 4, or 5 unshielded twisted-pair (UTP) cabling</li> <li>• 100BASE-TX ports: RJ-45 connectors, 2-pair Category 5 UTP cabling</li> <li>• 1000BASE-T ports: RJ-45 connectors, 4-pair Category 5 UTP cabling</li> <li>• 1000BASE-T SFP-based ports: RJ-45 connectors, 4-pair Category 5 UTP cabling</li> </ul> <b>Cisco Catalyst 3560-CX and 2960-CX SFP and SFP+ interfaces:</b> For information about supported SFP/SFP+ modules, refer to the Transceiver Compatibility matrix tables at <a href="http://www.cisco.com/c/en/us/support/interfaces-modules/transceiver-modules/products-device-support-tables-list.html">http://www.cisco.com/c/en/us/support/interfaces-modules/transceiver-modules/products-device-support-tables-list.html</a>		
<b>Power connectors</b>	<ul style="list-style-type: none"> <li>• Customers can provide power to a switch by using the internal power supply. The connector is located at the back of the switch. The internal power supply is an autoranging unit.</li> <li>• The internal power supply supports input voltages between 100 and 240VAC.</li> <li>• Use the supplied AC power cord to connect the AC power connector to an AC power outlet.</li> </ul> <b>Note:</b> The Cisco Catalyst WS-C3560CX-8PT-S has an option for an external AC-DC or DC-DC power adapter if desired.		
<b>Indicators</b>	Per-port status: Link integrity, disabled, activity, speed, full-duplex System status: System, link status, link duplex, link speed		
<b>Dimensions (H x W x D)</b>	<b>Cisco Catalyst 3560-CX and 2960-CX</b>	<b>Inches</b>	<b>Centimeters</b>
	2960CX-8TC-L	1.75 x 10.6 x 8.4	4.44 x 26.9 x 21.3
	2960CX-8PC-L	1.75 x 10.6 x 9.4	4.44 x 26.9 x 23.8
	3560CX-8TC-S	1.75 x 10.6 x 8.4	4.44 x 26.9 x 21.3
	3560CX-12TC-S	1.75 x 10.6 x 8.4	4.44 x 26.9 x 21.3
	3560CX-8PC-S	1.75 x 10.6 x 9.4	4.44 x 26.9 x 23.8
	3560CX-12PC-S	1.75 x 10.6 x 9.4	4.44 x 26.9 x 23.8
	3560CX-12PD-S	1.75 x 10.6 x 9.4	4.44 x 26.9 x 23.8
	3560CX-8PT-S	1.75 x 10.6 x 7.0	4.44 x 26.9 x 17.7
	3560CX-8XPD-S	1.75 x 10.6 x 10.4	4.44 x 26.9 x 26.4

Description	Specification				
<b>Weight</b>	<b>Cisco Catalyst 3560-CX and 2960-CX</b>	<b>Pounds</b>	<b>Kilograms</b>		
	2960CX-8TC-L	3.8	1.72		
	2960CX-8PC-L	5.0	2.27		
	3560CX-8TC-S	3.8	1.72		
	3560CX-12TC-S	3.9	1.77		
	3560CX-8PC-S	5.0	2.27		
	3560CX-12PC-S	5.1	2.31		
	3560CX-12PD-S	5.1	2.31		
	3560CX-8PT-S	3.5	1.58		
3560CX-8XPD-S	6.0	2.72			
<b>Environmental ranges</b>		<b>Cisco Catalyst 3560-CX</b>		<b>Cisco Catalyst 2960-CX</b>	
	Operating <sup>†</sup> temperature up to 5000 ft (1524 m)	-5°C to +45°C**	+23°F to +113°F	-5°C to +45°C**	+23°F to +113°F
	Operating <sup>†</sup> temperature up to 10,000 ft (3048 m)	-5°C to +45°C	+23°F to +113°F	-5°C to +45°C	+23°F to +113°F
	Storage temperature up to 15,000 ft (4572 m)	-25°C to +70°C	-13°F to +158°F	-25°C to +70°C	-13°F to +158°F
	Operating altitude	Up to 3048 m	Up to 10,000 ft	Up to 3048 m	Up to 10,000 ft
	Storage altitude	Up to 4000 m	Up to 15,000 ft	Up to 4000 m	Up to 15,000 ft
	Operating relative humidity	5% to 95% noncondensing		5% to 95% noncondensing	
	Storage relative humidity	5% to 95% noncondensing		5% to 95% noncondensing	
<b>Mean time between failure (MTBF)</b>	<b>Cisco Catalyst 3560-CX</b>	<b>MTBF</b>	<b>Cisco Catalyst 2960-CX</b>	<b>MTBF</b>	
	3560CX-8TC-S	756,260	2960CX-8TC-L	756,260	
	3560CX-12TC-S	755,270	2960CX-8PC-L	569,530	
	3560CX-8PC-S	569,530			
	3560CX-12PC-S	553,140			
	3560CX-12PD-S	528,480			
	3560CX-8PT-S	737,740			
	3560CX-8XPD-S	528,480			

<sup>†</sup> Minimum ambient temperature for cold start is 0°C (+32°F)  
<sup>\*\*</sup> 10G SKUs have a maximum operating temperature of 40°C. For WS-C3560CX-8XPD-S, the max operating temperature will be 35°C when installed inverted and under fully loaded conditions (max. POE and 10G SFP+ transceivers installed)

Table 6 describes the power specifications for Cisco Catalyst 3560-CX and 2960-CX switches.

**Table 6.** Power Specifications for Cisco Catalyst 3560-C and 2960-C Series Compact Switches

Description	Specification			
<b>Measured 100% throughput power consumption</b>	<b>Cisco Catalyst 3560-CX</b>	<b>Switch Power Consumption Watts</b>	<b>Cisco Catalyst 2960-CX</b>	<b>Switch Power Consumption Watts</b>
	3560CX-8TC-S	18.8W	2960CX-8TC-L	18.8W
	3560CX-12TC-S	20.8W	2960CX-8PC-L	24.5W
	3560CX-8PC-S	24.4W		
	3560CX-12PC-S	26.3W		
	3560CX-12PD-S	29.5W		

Description	Specification					
	3560CX-8PT-S	Single uplink = 22.9W <sup>1</sup> Dual uplink = 24.3W <sup>1</sup>				
	3560CX-8XPD-S	35.2W				
Measured 10% throughput power consumption	<b>Cisco Catalyst 3560-CX</b>	<b>Switch Power Consumption Watts</b>		<b>Cisco Catalyst 2960-CX</b>	<b>Switch Power Consumption Watts</b>	
	3560CX-8TC-S	18.6W		2960CX-8TC-L	18.7W	
	3560CX-12TC-S	20.6W		2960CX-8PC-L	24.3W	
	3560CX-8PC-S	24.2W				
	3560CX-12PC-S	26.1W				
	3560CX-12PD-S	28.9W				
	3560CX-8PT-S	Single uplink = 22.8W <sup>1</sup> Dual uplink = 24.2W <sup>1</sup>				
	3560CX-8XPD-S	34.5W				
Measured 0% throughput power consumption (with EEE)	<b>Cisco Catalyst 3560-CX</b>	<b>Switch Power Consumption Watts</b>		<b>Cisco Catalyst 2960-CX</b>	<b>Switch Power Consumption Watts</b>	
	3560CX-8TC-S	14.8W		2960CX-8TC-L	15W	
	3560CX-12TC-S	15.6W		2960CX-8PC-L	20.4W	
	3560CX-8PC-S	21.3W				
	3560CX-12PC-S	21.3W				
	3560CX-12PD-S	24.9W				
	3560CX-8PT-S	Single uplink = 20.1W <sup>1</sup> Dual uplink = 21.3W <sup>1</sup>				
	3560CX-8XPD-S	32.7W				
Measured 100% throughput power consumption (with maximum possible PoE loads)	<b>Cisco Catalyst 3560-CX</b>	<b>Switch Power Consumption Watts</b>		<b>Cisco Catalyst 2960-CX</b>	<b>Switch Power Consumption Watts</b>	
	3560CX-8TC-S	NA		2960CX-8TC-L	NA	
	3560CX-12TC-S	NA		2960CX-8PC-L	161.4W	
	3560CX-8PC-S	269.1W				
	3560CX-12PC-S	275.2W				
	3560CX-12PD-S	278W				
	3560CX-8PT-S	180W				
	3560CX-8XPD-S	285.1W				
AC/DC input voltage and current	<b>Cisco Catalyst 3560-CX</b>			<b>Cisco Catalyst 2960-CX</b>		
		I/P Voltage	I/P Current		I/P voltage	I/P Current
	3560CX-8TC-S	100-240 VAC	0.5-0.2A	2960CX-8TC-L	100-240 VAC	0.5-0.2A
	3560CX-12TC-S	100-240 VAC	0.5-0.2A	2960CX-8PC-L	100-240 VAC	3.25-1.5A
	3560CX-8PC-S	100-240 VAC	3.25-1.5A			
	3560CX-12PC-S	100-240 VAC	3.25-1.5A			
	3560CX-12PD-S	100-240 VAC	3.25-1.5A			
	3560CX-8PT-S	18-60VDC	6.0-1.6A			
	3560CX-8XPD-S	100-240 VAC	3.25-1.5A			

Description	Specification							
Power rating	Cisco Catalyst 3560-CX				Cisco Catalyst 2960-CX			
		Watts	KVA	BTU		Watts	KVA	BTU
	3560CX-8TC-S	30	0.05	170.6	2960CX-8TC-L	30	0.05	170.6
	3560CX-12TC-S	30	0.05	170.6	2960CX-8PC-L	170	0.19	648.3 <sup>1</sup>
	3560CX-8PC-S	280	0.3	1023.6 <sup>1</sup>				
	3560CX-12PC-S	280	0.3	1023.6 <sup>1</sup>				
	3560CX-12PD-S	290	0.31	1057.7 <sup>1</sup>				
	3560CX-8PT-S	90	0.11	375.3 <sup>1</sup>				
	3560CX-8XPD-S	290	0.31	1057.7 <sup>1</sup>				
	<sup>1</sup> Switch dissipation only (excludes PoE, which is dissipated at the end device). Power measurements are best and worst case. Best case is 1 PoE+ connection. Worst case is 2 PoE connections.							
PoE and PoE+	<ul style="list-style-type: none"> <li>Maximum power supplied per Port for PoE+ is 30W</li> <li>Maximum power supplied per port for PoE: 15.4W</li> </ul>							
PoE Power Supply Characteristics	Capacity: 300W, Efficiency: 80 Plus Silver certified							
	% Load		Efficiency			Power Factor		
	• 20		• 85%			• 0.8		
	• 50		• 88%			• 0.9		
	• 100		• 90%			• 0.95		

Table 7 shows switch management and standards support.

**Table 7.** Management and Standards Support for Cisco Catalyst 3560-CX and 2960-CX Series Compact Switches

Description	Specification	
Management	<ul style="list-style-type: none"> <li>BRIDGE-MIB</li> <li>CISCO-CABLE-DIAG-MIB</li> <li>CISCO-CDP-MIB</li> <li>CISCO-CLUSTER-MIB</li> <li>CISCO-CONFIG-COPY-MIB</li> <li>CISCO-CONFIG-MAN-MIB</li> <li>CISCO-DHCP-SNOOPING-MIB</li> <li>CISCO-ENTITY-VENDORTYPE-OID-MIB</li> <li>CISCO-ENVMON-MIB</li> <li>CISCO-ERR-DISABLE-MIB</li> <li>CISCO-FLASH-MIB</li> <li>CISCO-FTP-CLIENT-MIB</li> <li>CISCO-IGMP-FILTER-MIB</li> <li>CISCO-IMAGE-MIB</li> <li>CISCO-IP-STAT-MIB</li> <li>CISCO-LAG-MIB</li> <li>CISCO-MAC-NOTIFICATION-MIB</li> <li>CISCO-MEMORY-POOL-MIB</li> <li>CISCO-PAGP-MIB</li> <li>CISCO-PING-MIB</li> <li>CISCO-POE-EXTENSIONS-MIB</li> <li>CISCO-PORT-QOS-MIB</li> <li>CISCO-PORT-SECURITY-MIB</li> <li>CISCO-PORT-STORM-CONTROL-MIB</li> <li>CISCO-PRODUCTS-MIB</li> <li>CISCO-PROCESS-MIB</li> <li>CISCO-RTTMON-MIB</li> </ul>	<ul style="list-style-type: none"> <li>CISCO-TC-MIB</li> <li>CISCO-TCP-MIB</li> <li>CISCO-UDLDP-MIB</li> <li>CISCO-VLAN-IFTABLE</li> <li>RELATIONSHIP-MIB</li> <li>CISCO-VLAN-MEMBERSHIP-MIB</li> <li>CISCO-VTP-MIB</li> <li>ENTITY-MIB</li> <li>ETHERLIKE-MIB</li> <li>IEEE8021-PAE-MIB</li> <li>IEEE8023-LAG-MIB</li> <li>IF-MIB</li> <li>INET-ADDRESS-MIB</li> <li>OLD-CISCO-CHASSIS-MIB</li> <li>OLD-CISCO-FLASH-MIB</li> <li>OLD-CISCO-INTERFACES-MIB</li> <li>OLD-CISCO-IP-MIB</li> <li>OLD-CISCO-SYS-MIB</li> <li>OLD-CISCO-TCP-MIB</li> <li>OLD-CISCO-TS-MIB</li> <li>RFC1213-MIB</li> <li>RMON-MIB</li> <li>RMON2-MIB</li> <li>SNMP-FRAMEWORK-MIB</li> <li>SNMP-MPD-MIB</li> <li>SNMP-NOTIFICATION-MIB</li> <li>SNMP-TARGET-MIB</li> </ul>

Description	Specification	
	<ul style="list-style-type: none"> <li>• CISCO-SMI-MIB</li> <li>• CISCO-STP-EXTENSIONS-MIB</li> <li>• CISCO-SYSLOG-MIB</li> </ul>	<ul style="list-style-type: none"> <li>• SNMPv2-MIB</li> <li>• TCP-MIB</li> <li>• UDP-MIB</li> <li>• ePM MIB</li> </ul>
<b>Standards</b>	<ul style="list-style-type: none"> <li>• IEEE 802.1D Spanning Tree Protocol</li> <li>• IEEE 802.1p CoS Prioritization</li> <li>• IEEE 802.1Q VLAN</li> <li>• IEEE 802.1s</li> <li>• IEEE 802.1w</li> <li>• IEEE 802.1x</li> <li>• IEEE 802.1AB (LLDP)</li> <li>• IEEE 802.3ad</li> <li>• IEEE 802.3af</li> <li>• IEEE 802.3ah (100BASE-X single/multimode fiber only)</li> <li>• IEEE 802.3x full duplex on 10BASE-T, 100BASE-TX, and 1000BASE-T ports</li> <li>• IEEE 802.3 10BASE-T specification</li> <li>• IEEE 802.3u 100BASE-TX specification</li> <li>• IEEE 802.3ab 1000BASE-T specification</li> <li>• IEEE 802.3z 1000BASE-X specification</li> </ul>	<ul style="list-style-type: none"> <li>• 100BASE-BX (SFP)</li> <li>• 100BASE-FX (SFP)</li> <li>• 100BASE-LX (SFP)</li> <li>• 1000BASE-BX (SFP)</li> <li>• 1000BASE-SX (SFP)</li> <li>• 1000BASE-LX/LH (SFP)</li> <li>• 1000BASE-ZX (SFP)</li> <li>• 1000BASE-CWDM SFP 1470 nm</li> <li>• 1000BASE-CWDM SFP 1490 nm</li> <li>• 1000BASE-CWDM SFP 1510 nm</li> <li>• 1000BASE-CWDM SFP 1530 nm</li> <li>• 1000BASE-CWDM SFP 1550 nm</li> <li>• 1000BASE-CWDM SFP 1570 nm</li> <li>• 1000BASE-CWDM SFP 1590 nm</li> <li>• 1000BASE-CWDM SFP 1610 nm</li> <li>• RMON I and II standards</li> <li>• SNMPv1, SNMPv2c, and SNMPv3</li> </ul>
<b>RFC compliance</b>	<ul style="list-style-type: none"> <li>• RFC 768: UDP</li> <li>• RFC 783: TFTP</li> <li>• RFC 791: IP</li> <li>• RFC 792: ICMP</li> <li>• RFC 793: TCP</li> <li>• RFC 826: ARP</li> <li>• RFC 854: Telnet</li> <li>• RFC 951: Bootstrap Protocol</li> <li>• RFC 1542: BOOTP Extensions</li> <li>• RFC 959: FTP</li> <li>• RFC 1058: RIP Routing</li> <li>• RFC 1112: IP Multicast and IGMP</li> <li>• RFC 1157: SNMPv1</li> <li>• RFC 1166: IP Addresses</li> <li>• RFC 1253: OSPF Routing</li> <li>• RFC 1256: ICMP Router Discovery</li> <li>• RFC 1305: NTP</li> <li>• RFC 1492: TACACS+</li> <li>• RFC 1493: Bridge MIB</li> <li>• RFC 1542: Bootstrap Protocol</li> <li>• RFC 1583: OSPFv2</li> <li>• RFC 1643: Ethernet Interface MIB</li> <li>• RFC 1723: RIPv2 Routing</li> <li>• RFC 1757: RMON</li> </ul>	<ul style="list-style-type: none"> <li>• RFC 1812: IP Routing</li> <li>• RFC 1901: SNMPv2C</li> <li>• RFC 1902-1907: SNMPv2</li> <li>• RFC 1981: MTU Path Discovery IPv6</li> <li>• RFC 2068: HTTP</li> <li>• RFC 2080: RIP for IPv6</li> <li>• RFC 2131: DHCP</li> <li>• RFC 2138: RADIUS</li> <li>• RFC 2233: IF MIB</li> <li>• RFC 2236: IP Multicast</li> <li>• RFC 2328: OSPFv2</li> <li>• RFC 2273-2275: SNMPv3</li> <li>• RFC 2373: IPv6 Aggregatable Adrs</li> <li>• RFC 2453: RIPv2 Routing</li> <li>• RFC 2460: IPv6 protocol</li> <li>• RFC 2461: IPv6 Neighbor Discovery</li> <li>• RFC 2462: IPv6 Autoconfiguration</li> <li>• RFC 2463: ICMP IPv6</li> <li>• RFC 2474: DiffServ Precedence</li> <li>• RFC 2597: Assured Forwarding</li> <li>• RFC 2598: Expedited Forwarding</li> <li>• RFC 2571: SNMP Management</li> <li>• RFC 2740: OSPF for IPv6</li> <li>• RFC 3046: DHCP Relay Agent Information Option</li> <li>• RFC 3101, 1587: NSSAs</li> <li>• RFC 3376: IGMPv3</li> <li>• RFC 3580: 802.1x RADIUS</li> </ul>
<b>Note:</b> RFC, MIB and Standards compliance is dependent on IOS Level.		



Table 8 shows safety and compliance information.

**Table 8.** Safety and Compliance Support

Description	Specification
<b>Safety standards</b>	<ul style="list-style-type: none"> <li>• UL 60950-1</li> <li>• CAN/CSA 22.2 No. 60950-1</li> <li>• EN 60950-1</li> <li>• IEC 60950-1</li> <li>• CE Marking</li> <li>• GB 4943</li> <li>• IEC 60825</li> </ul>
<b>Electromagnetic emissions certifications</b>	<ul style="list-style-type: none"> <li>• FCC Part 15, CFR 47, Class A, North America</li> <li>• EN 55022 (CISPR22) and EN 55024 (CISPR24), CE marking, European Union</li> <li>• AS/NZS, Class A, CISPR22:2004 or EN55022, Australia and New Zealand</li> <li>• VCCI Class A, V-3/2007.04, Japan</li> <li>• KCC (Formerly MIC, GB17625.1-1998) Class A, KN24/KN22, Korea</li> <li>• ANATEL, Brazil</li> <li>• CCC, China</li> <li>• GOST, Russia</li> </ul>
<b>Environmental</b>	Reduction of Hazardous Substances (ROHS) 6
<b>Telco</b>	Common Language Equipment Identifier (CLEI) code

## Ordering Information

To place an order, consult Table 9 for ordering information and visit [Cisco Commerce Workspace](#).

**Table 9.** Ordering Information for Cisco Catalyst 3560-CX and 2960-CX Series Compact Switches

Cisco Catalyst 3560-CX Compact Switches	
Part Number	Description
<b>WS-C3560CX-8TC-S</b>	3560-CX Switch 8 GE, uplinks: 2 x 1G SFP and 2 x 1G copper, IP Base
<b>WS-C3560CX-12TC-S</b>	3560-CX Switch 12 GE, uplinks: 2 x 1G SFP and 2 x 1G copper, IP Base
<b>WS-C3560CX-8PC-S</b>	3560-CX Switch 8 GE PoE+, uplinks: 2 x 1G SFP and 2 x 1G copper, IP Base
<b>WS-C3560CX-12PC-S</b>	3560-CX Switch 12 GE PoE+, uplinks: 2 x 1G SFP and 2 x 1G copper, IP Base
<b>WS-C3560CX-12PD-S</b>	3560-CX Switch 12 GE PoE+, uplinks: 2 x 10G SFP+ and 2 x 1G copper, IP Base
<b>WS-C3560CX-8PT-S</b>	3560-CX PD PSE Switch 8 GE PoE+, uplinks: 2 x 1G copper (Cisco UPOE powered input), IP Base
<b>WS-C3560CX-8XPD-S</b>	3560-CX Switch 6 GE PoE+, 2 MultiGE PoE+, uplinks: 2 x 10G SFP+, IP Base
Cisco Catalyst 2960-CX Compact Switches	
Part Number	Description
<b>WS-C2960CX-8TC-L</b>	2960-CX Switch 8 GE, uplinks: 2 x 1G SFP and 2 x 1G copper LAN Base
<b>WS-C2960CX-8PC-L</b>	2960-CX Switch, 8 GE PoE+, uplinks: 2 x 1G SFP and 2 x 1G copper LAN Base
Cisco Catalyst 3560-CX and 2960-CX Accessories	
Part Number	Description
<b>PWR-CLP=</b>	Power clip for the 3560-CX and 2960-CX compact switches
<b>PWR-ADPT=</b>	AC-DC power adapter for the WS-C3560CX-8PT-S compact switch
<b>PWR-ADPT-DC=</b>	DC-DC power adapter for the WS-C3560CX-8PT-S compact switch
<b>PWR-ADPT-BRKT=</b>	Power adapter bracket for the WS-C3560CX-8PT-S compact switch (needs either CMPCT-DIN-MNT= or CMPCT-MGNT-TRAY =) to work
<b>CMPCT-CBLE-GRD=</b>	Cable guard for the 3560-CX and 2960-CX compact switches
<b>CMPCT-MGNT-TRAY =</b>	Magnet and Mounting Tray for 3560-CX and 2960-CX compact switches

Cisco Catalyst 3560-CX and 2960-CX Accessories	
Part Number	Description
<b>CMPCT-DIN-MNT=</b>	DIN Rail Mount for 3560-CX and 2960-CX compact switches
<b>RCKMNT-19-CMPCT=</b>	19-Inch Rack Mounting Brackets for 3560-CX and 2960-CX compact switches
<b>RCKMNT-23-CMPCT=</b>	23- and 24-Inch Rack Mounting Brackets for 3560-CX and 2960-CX compact switches
Cisco Catalyst 3560-CX Software Licenses	
Part Number	Description
<b>L-C3560CX-RTU=</b>	Cisco Catalyst 3560-CX IP Base to IP Services RTU electronic license
<b>C3560CX-RTU=</b>	Cisco Catalyst 3560-CX IP Base to IP Services RTU paper license

## Warranty Information

Cisco Catalyst 3560-CX and 2960-CX Series Switches come with an enhanced limited lifetime hardware warranty that includes 90 days of Cisco Technical Assistance Center (TAC) support and next-business-day hardware replacement free of charge (see Table 10 for details).

**Table 10.** Enhanced Limited Lifetime Hardware Warranty

Cisco Enhanced Limited Lifetime Hardware Warranty	
<b>Device covered</b>	Applies to Cisco Catalyst 3560-CX and 2960-CX Series compact switches.
<b>Warranty duration</b>	As long as the original customer owns the product.
<b>EoL policy</b>	In the event of discontinuance of product manufacture, Cisco warranty support is limited to 5 years from the announcement of discontinuance.
<b>Hardware replacement</b>	Cisco or its service center will use commercially reasonable efforts to ship a replacement for next business day delivery, where available. Otherwise, a replacement will be shipped within 10 working days after receipt of the RMA request. Actual delivery times might vary depending on customer location.
<b>Effective date</b>	Hardware warranty commences from the date of shipment to customer (and in case of resale by a Cisco reseller, not more than 90 days after original shipment by Cisco).
<b>TAC support</b>	Cisco will provide during business hours, 8 hours per day, 5 days per week basic configuration, diagnosis, and troubleshooting of device-level problems for up to a 90-day period from the date of shipment of the originally purchased Cisco Catalyst 2960 and 3560 product. This support does not include solution or network-level support beyond the specific device under consideration.
<b>Cisco.com access</b>	Warranty allows guest access only to Cisco.com.

Your formal warranty statement, including the warranty applicable to Cisco software, appears in the Cisco information packet that accompanies your Cisco product. We encourage you to review carefully the warranty statement shipped with your specific product before use. Cisco reserves the right to refund the purchase price as its exclusive warranty remedy.

Adding a Cisco technical services contract to your device coverage provides access to the Cisco Technical Assistance Center (TAC) beyond the 90-day period allowed by the warranty. It also can provide a variety of hardware replacement options to meet critical business needs, as well as updates for licensed premium Cisco IOS Software, and registered access to the extensive Cisco.com knowledge base and support tools.

For additional information about warranty terms, visit <http://www.cisco.com/go/warranty>.

## Cisco and Partner Services

Enable the innovative, secure, intelligent edge using personalized services from Cisco and our partners. Through a discovery process that begins with understanding your business objectives, we help you integrate the next-generation Cisco Catalyst fixed switches into your architecture and incorporate network services onto those platforms. Sharing knowledge and leading practices, we support your success every step of the way as you deploy, absorb, manage, and scale new technology. Choose from a flexible suite of support services (Table 11), designed to meet your business needs and help you maintain high-quality network performance while controlling operational costs.

**Table 11.** Technical Services Available for Cisco Catalyst 3560-CX and 2960-CX Series Compact Switches

Technical Services
<b>Cisco SMARTnet® Service</b> <ul style="list-style-type: none"><li>• Around-the-clock, global access to the Cisco Technical Assistance Center (TAC)</li><li>• Unrestricted access to the extensive Cisco.com knowledge base and tools</li><li>• Next-business-day, 8x5x4, 24x7x4, and 24x7x2 advance hardware replacement and onsite parts replacement and installation available</li><li>• Ongoing operating system software updates within the licensed feature set</li><li>• Proactive diagnostics and real-time alerts on Smart Call Home-enabled devices</li></ul>
<b>Cisco Smart Foundation Service</b> <ul style="list-style-type: none"><li>• Next business day advance hardware replacement as available</li><li>• Business hours access to SMB TAC (access levels vary by region)</li><li>• Access to Cisco.com SMB knowledge base</li><li>• Online technical resources through Smart Foundation Portal</li><li>• Operating system software bug fixes and patches</li></ul>
<b>Cisco Focused Technical Support Services</b> <ul style="list-style-type: none"><li>• 3 levels of premium, high-touch services are available</li><li>• Cisco High-Touch Operations Management Service</li><li>• Cisco High-Touch Technical Support Service</li><li>• Cisco High-Touch Engineering Service</li><li>• Valid Cisco SMARTnet or SP Base contracts on all network equipment are required</li></ul>

## Cisco Capital

### Financing to Help You Achieve Your Objectives

Cisco Capital can help you acquire the technology you need to achieve your objectives and stay competitive. We can help you reduce CapEx. Accelerate your growth. Optimize your investment dollars and ROI. Cisco Capital financing gives you flexibility in acquiring hardware, software, services, and complementary third-party equipment. And there's just one predictable payment. Cisco Capital is available in more than 100 countries. [Learn more.](#)

### Learn More

For more information, contact your Cisco sales account rep or visit <http://www.cisco.com/go/compactswitches>.



---

**Americas Headquarters**  
Cisco Systems, Inc.  
San Jose, CA

**Asia Pacific Headquarters**  
Cisco Systems (USA) Pte. Ltd.  
Singapore

**Europe Headquarters**  
Cisco Systems International BV Amsterdam,  
The Netherlands

Cisco has more than 200 offices worldwide. Addresses, phone numbers, and fax numbers are listed on the Cisco Website at [www.cisco.com/go/offices](http://www.cisco.com/go/offices).

 Cisco and the Cisco logo are trademarks or registered trademarks of Cisco and/or its affiliates in the U.S. and other countries. To view a list of Cisco trademarks, go to this URL: [www.cisco.com/go/trademarks](http://www.cisco.com/go/trademarks). Third party trademarks mentioned are the property of their respective owners. The use of the word partner does not imply a partnership relationship between Cisco and any other company. (1110R)

# **DATASHEET SWITCH CISCO 3850**

# Cisco Catalyst 3850 Series Switches

## The Digital Transformation: Converged Wired and Wireless Access and Aggregation

The promise of digital for your business is all about innovating more quickly while reducing risk, cost, and complexity. It will be your network that forms the foundation of your business's transformation.

But supporting your digital organization will require your network to move beyond just connectivity to be a platform for insights, automation, and security.

This is the power of the Cisco® Digital Network Architecture (DNA).

Cisco DNA is a monumental shift on how to design and build networks. The Cisco Catalyst® 3850 Series, as part of the Cisco DNA portfolio of next-generation enterprise-class stackable Ethernet and Multigigabit Ethernet access and aggregation layer switches, securely enables time-saving virtualization, greater automation, and valuable analytics data that directly address your evolving business needs, including less cost to install and operate.

The Cisco Catalyst 3850 Series provides capabilities that ideally suited to support the convergence of wired and wireless access. The new Cisco Unified Access Data™ Plane (UADP) application-specific integrated circuit (ASIC) powers the switch and enables uniform wired-wireless policy enforcement, application visibility, flexibility, and application optimization. This convergence is built on the resilience of the new and improved Cisco StackWise®-480 technology.

The Cisco Catalyst 3850 Series Switches support full IEEE 802.3at Power over Ethernet Plus (PoE+), Cisco Universal Power over Ethernet (Cisco UPOE), modular and field-replaceable network modules, RJ45 and fiber-based downlink interfaces, and redundant fans and power supplies.

### Product Overview

- Integrated wireless controller capability with:
  - Up to 40G of wireless capacity per switch (48-port RJ45 models)
  - Support for up to 100 access points and 2000 wireless clients on each switching entity (switch or stack)
- 24 and 48 10/100/1000Mbps data PoE+ and Cisco UPOE models with energy-efficient Ethernet (EEE)
- 24 and 48 100Mbps/1/2.5/5/10 Gbps Cisco UPOE models with energy-efficient Ethernet (EEE)
- 12- and 24-port 1 Gigabit Ethernet SFP-based models
- 12- and 24-port 1/10 Gigabit Ethernet SFP+-based models
- 48-port 1/10 Gigabit Ethernet SFP+ model with 4 fixed 40 Gigabit Ethernet QSFP+ uplinks
- Cisco StackWise-480 technology provides scalability and resiliency with 480 Gbps of stack throughput<sup>1</sup>
- Cisco StackPower™ technology provides power stacking among stack members for power redundancy<sup>1</sup>

---

<sup>1</sup> StackWise and StackPower technologies are not supported on the 48-port SFP+ switch model.

- Five optional uplink modules<sup>2</sup> with 4 x Gigabit Ethernet, 2 x 10 Gigabit Ethernet, 4 x 10 Gigabit Ethernet<sup>3</sup>, 8 x 10 Gigabit Ethernet<sup>4</sup>, or 2 x 40 Gigabit Ethernet QSFP+<sup>4</sup> ports
- Dual redundant, modular power supplies and three modular fans providing redundancy
- Full IEEE 802.3at (PoE+) with 30W power on all copper ports in 1 rack unit (RU) form factor
- Cisco UPOE with 60W power per port in 1 rack unit (RU) form factor
- IEEE 802.3bz (2.5/5 G/s BASE-T) to go beyond 1 Gb/s with existing Cat5e and Cat6
- IEEE 802.3ba AV Bridging (AVB) built-in to provide better AV experience for including improved time synchronization and QoS.
- Software support for IPv4 and IPv6 routing, multicast routing, modular quality of service (QoS), Flexible NetFlow (FNF), and enhanced security features
- Single universal Cisco IOS<sup>®</sup> Software image across all license levels, providing an easy upgrade path for software features
- DNA services delivered through Cisco ONE<sup>™</sup> Software, providing simplified, high-value solutions with license portability and flexibility
- Enhanced limited lifetime warranty (E-LLW) with next business day (NBD) advance hardware replacement and 90-day access to Cisco Technical Assistance Center (TAC) support

## Switch Models and Configurations

All switches ship with one of the five power supplies (350WAC, 715WAC, 750WAC, 1100WAC, or 440WDC)<sup>5</sup>. Figures 1 through 3 show the Cisco Catalyst 3850 Series Switches.

**Figure 1.** Cisco Catalyst 3850 Series Switches



**Figure 2.** Cisco Catalyst 3850 Switches with 12 and 24 1/10 Gigabit Ethernet SFP+ Ports



<sup>2</sup> Optional uplink modules are not supported on the 48-port 10G SFP+ switch model.

<sup>3</sup> Compatible only with the 48-port RJ45 models and with the 12-port (or higher) 10 Gigabit capable models.

<sup>4</sup> Compatible only with Cisco Catalyst 3850 Multigigabit and 24-port SFP+ switch models.

<sup>5</sup> The 48-port 10G SFP+ switch model will only support dedicated power supplies with front-to-back and back-to-front configurations.

**Figure 3.** Cisco Catalyst 3850 Switches with 12 and 24 1 Gigabit Ethernet SFP Ports



**Figure 4.** Cisco Catalyst 3850 Switches with 10 Gigabit Ethernet 48 ports



Table 1 shows the Cisco Catalyst 3850 Series configurations.

**Table 1.** Cisco Catalyst 3850 Series Configurations

Models	Total 10/100/1000 or SFP or SFP+ Ports	Default AC Power Supply	Available PoE Power	StackWise-480	StackPower
WS-C3850-24T	24	350WAC	-	Yes	Yes
WS-C3850-48T	48				
WS-C3850-24P	24 PoE+	715WAC	435W		
WS-C3850-48P	48 PoE+				
WS-C3850-48F	48 PoE+	1100WAC	800W		
WS-C3850-24U	24 UPOE	1100WAC	800W		
WS-C3850-48U	48 UPOE	1100WAC	800W		
WS-C3850-24XU	24 UPOE (100Mbps/1/2.5/5/10 Gbps)	1100WAC	580W		
WS-C3850-12X48U	48 UPOE (with 12 100Mbps/1/2.5/5/10 Gbps Ports)	1100WAC	630W		
WS-C3850-12S	12 SFP	350WAC			
WS-C3850-24S	24 SFP				
WS-C3850-12XS	12 1/10G SFP+	350WAC	-	No	No
WS-C3850-24XS	24 1/10G SFP+	715 WAC	-		
WS-C3850-48XS	48 1/10G SFP+	750WAC (front to back)	-		

## Network Modules

The Cisco Catalyst 3850 Series Switches support five optional network modules for uplink ports. The default switch configuration does not include the network module<sup>6</sup>. At the time of switch purchase the customer has the flexibility to choose from the network modules described in Table 2.

<sup>6</sup> Network modules are not supported on the 48-port 10G SFP+ switch model, which comes with four fixed 40 Gigabit Ethernet QSFP+ uplinks.



Figure 5 shows the following network modules:

- 4 x Gigabit Ethernet with Small Form-Factor Pluggable (SFP) receptacles
- 2 x 10 Gigabit Ethernet with SFP+ or 4 x Gigabit Ethernet with SFP receptacles
- 4 x 10 Gigabit Ethernet with SFP+ receptacles (supported only on the 48-port Gigabit Ethernet models or on the 12-port or higher 10 Gigabit Ethernet models)

**Figure 5.** Network Modules with Four Gigabit Ethernet, Two 10 Gigabit Ethernet SFP+, or Four 10 Gigabit Ethernet SFP+ Interfaces



Figure 6 shows the following network modules:

- 8 x 10 Gigabit Ethernet with Small Form-Factor Pluggable+ (SFP+) receptacles
- 2 x 40 Gigabit Ethernet with Quad Small Form-Factor Pluggable+ (QSFP+) receptacles

**Figure 6.** Network Modules with Two 40 Gigabit Ethernet QSFP+ or Eight 10 Gigabit Ethernet SFP+ Interfaces



**Table 2.** Network Module Numbers and Descriptions

Product Number	Product Description	WS-C3850-24XU WS-C3850-12X48U	WS-C3850-12XS WS-C3850-24XS
<b>C3850-NM-4-1G</b>	4 x Gigabit Ethernet network modules	Supported	Not supported
<b>C3850-NM-2-10G</b>	4 x Gigabit Ethernet/2 x 10 Gigabit Ethernet network modules	Supported	Not supported
<b>C3850-NM-4-10G</b>	4 x Gigabit Ethernet/4 x 10 Gigabit Ethernet network modules	Supported	Supported
<b>C3850-NM-8-10G</b>	8 x Gigabit Ethernet/8 x 10 Gigabit Ethernet network modules	Supported	See note
<b>C3850-NM-2-40G</b>	2 x 40 Gigabit Ethernet network modules	Supported	See note

**Note:** The C3850-NM-4-10G module is supported only on the 48-port Gigabit Ethernet models or on the 12-port or higher 10 Gigabit Ethernet models. The C3850-NM-8x10G and C3850-NM-2x40G modules are supported on the 24-port and 48-port multigigabit switches and also on the 24-port 10G SFP+ switch model. The C3850-NM-4-1G and C3850-NM-2-10G modules are not supported on the 12-port and 24-port SFP+ models.

**Table 3.** Network Module Compatibility Matrix

Models	Network Modules
WS-C3850-24T	C3850-NM-4-1G, C3850-NM-2-10G
WS-C3850-48T	C3850-NM-4-1G, C3850-NM-2-10G, C3850-NM-4-10G
WS-C3850-24P	C3850-NM-4-1G, C3850-NM-2-10G
WS-C3850-48P	C3850-NM-4-1G, C3850-NM-2-10G, C3850-NM-4-10G
WS-C3850-48F	C3850-NM-4-1G, C3850-NM-2-10G, C3850-NM-4-10G
WS-C3850-24U	C3850-NM-4-1G, C3850-NM-2-10G
WS-C3850-48U	C3850-NM-4-1G, C3850-NM-2-10G, C3850-NM-4-10G
WS-C3850-24XU	C3850-NM-4-1G, C3850-NM-2-10G, C3850-NM-4-10G, C3850-NM-8-10G, C3850-NM-2-40G
WS-C3850-12X48U	C3850-NM-4-1G, C3850-NM-2-10G, C3850-NM-4-10G, C3850-NM-8-10G, C3850-NM-2-40G
WS-C3850-12S	C3850-NM-4-1G, C3850-NM-2-10G
WS-C3850-24S	C3850-NM-4-1G, C3850-NM-2-10G
WS-C3850-12XS	C3850-NM-4-10G
WS-C3850-24XS	C3850-NM-4-10G, C3850-NM-8-10G, C3850-NM-2-40G
WS-C3850-48XS	None

An SFP+ receptacle supports both 10 Gigabit Ethernet and Gigabit Ethernet modules, allowing customers to use their investment in Gigabit Ethernet SFP modules and upgrade to 10 Gigabit Ethernet when business demands change without having to do a comprehensive upgrade of the access switch. In contrast, SFP receptacles can be used only as Gigabit Ethernet ports, as shown in the examples in Table 4.

**Table 4.** Network Module Configuration Examples

Network Module	Interface Options	
	10 Gigabit Ethernet SFP+ Ports	Gigabit Ethernet SFP Ports
4 x Gigabit Ethernet	0	4
4 x Gigabit Ethernet/2 x10 Gigabit Ethernet network modules	2	0
	1	3
	2	2
	0	4
4 x Gigabit Ethernet/4 x10 Gigabit Ethernet network modules	4	0
	0	4
	2	2
	3	1
	1	3

## Dual Redundant Modular Power Supplies

The Cisco Catalyst 3850 Series Switches support dual redundant power supplies<sup>7</sup>. The switch ships with one power supply by default, and the second power supply can be purchased at the time of ordering the switch or at a later time. If only one power supply is installed, it should always be in power supply bay 1. The switch also ships with three field-replaceable fans. (See Figure 7.)

<sup>7</sup> The 48-port 10G SFP+ switch model will only support dedicated power supplies with front-to-back and back-to-front configurations.

**Figure 7.** Dual Redundant Power Supplies



Table 5 shows the different power supplies available in these switches and available PoE power.

**Table 5.** Power Supply Models

Models	Default Power Supply	Available PoE Power
24-port data switch	PWR-C1-350WAC	-
48-port data switch		
24-port PoE switch	PWR-C1-715WAC	435W
48-port PoE switch		
48-port full PoE switch	PWR-C1-1100WAC	800W
24-port UPOE switch	PWR-C1-1100WAC	800W
48-port UPOE switch		
24-port Multigigabit UPOE switch	PWR-C1-1100WAC	580W
48-port Multigigabit UPOE switch	PWR-C1-1100WAC	630W
12-port SFP switch	PWR-C1-350WAC	-
24-port SFP switch		
12-port SFP+ switch	PWR-C1-350WAC	-
24-port SFP+ switch	PWR-C1-715WAC	-
48-port SFP+ switch (WS-C3850-48XS-S and WS-C3850-48XS-E)	PWR-C3-750WAC-R	-
48-port SFP+ switch (WS-C3850-48XS-F-S and WS-C3850-48XS-F-E)	PWR-C3-750WAC-F	-

In addition to the power supplies listed in Table 5, a 440WDC power supply is available as a configuration option and also as a spare (that is, it can be ordered separately) on all switch models. The DC power supply also delivers PoE capabilities for maximum flexibility (refer to Table 6 for available PoE budget with DC power supplies). Customers can mix and match the AC and DC power supplies in the two available power supply slots. Any of these power supplies can be installed in any of the switches.

**Table 6.** Available PoE with DC Power Supply

Model	Number of 440WDC Power Supplies	Total Available PoE Budget
24-port PoE switch	1	220W
	2	660W
48-port PoE switch	1	185W
	2	625W
24-port Mgig UPoE switch	2	360W
48-port Mgig UPoE switch	2	410W

## Power over Ethernet Plus (PoE+)

In addition to PoE (IEEE 802.3af), the Cisco Catalyst 3850 Series Switches support PoE+ (IEEE 802.3at standard), which provides up to 30W of power per port. The Cisco Catalyst 3850 Series Switches can provide a lower total cost of ownership (TCO) for deployments that incorporate Cisco IP phones, Cisco Aironet® wireless LAN (WLAN) access points, or any IEEE 802.3at-compliant end device. PoE removes the need for wall power to each PoE-enabled device and eliminates the cost for additional electrical cabling and circuits that would otherwise be necessary in IP phone and WLAN deployments. Table 7 shows the power supply combinations required for different PoE needs.

**Table 7.** Power Supply Requirements for PoE and PoE+

	24-Port PoE Switch	48-Port PoE Switch
<b>PoE on all ports (15.4W per port)</b>	One PWR-C1-715WAC	One PWR-C1-1100WAC or two PWR-C1-715WAC
<b>PoE+ on all ports (30W per port)</b>	One PWR-C1-1100WAC or two PWR-C1-715WAC	Two PWR-C1-1100WAC or one PWR-C1-1100WAC and one PWR-C1-715WAC

## Cisco Universal Power over Ethernet (UPOE)

Cisco Universal Power over Ethernet (Table 8) is a breakthrough technology, offering the following services and benefits.

- 60W per port to enable a variety of end devices such as Samsung VDI client, BT IP turret systems in trading floors, Cisco Catalyst compact switches in retail/hospitality environments, personal Cisco TelePresence® systems, and physical access control devices
- High availability for power and guaranteed uninterrupted services, a requirement for critical applications (e911)
- Lowering OpEx by providing network resiliency at lower cost by consolidating backup power into the wiring closet
- Faster deployment of new campus access networking infrastructures by eliminating the need for a power outlet for every endpoint

**Table 8.** Power Supply Requirements for UPOE

	24-Port UPOE Switch	48-Port UPOE Switch	24-Port Multigigabit UPOE Switch	48-Port Multigigabit UPOE Switch
<b>UPOE (60W per port) on all (24 port switch) or max. 30 ports (48 port switch)</b>	One PWR-C1-1100WAC and one PWR-C1-715WAC	Two PWR-C1-1100WAC	Two PWR-C1-1100WAC	Two PWR-C1-1100WAC

## Cisco Catalyst Multigigabit Ethernet Technology

Cisco Multigigabit Ethernet is a unique Cisco innovation to the new Cisco Catalyst Ethernet Access Switches. With the enormous growth of 802.11ac and new wireless applications, wireless devices are promoting the demand for more network bandwidth. This creates a need for a technology that supports speeds higher than 1 Gbps on all cabling infrastructure. Cisco Multigigabit technology allows you to achieve bandwidth speeds from 1 Gbps through 10 Gbps over traditional Cat 5e cabling or above. In addition, the Multigigabit ports on select Cisco Catalyst switches support UPOE, which is increasingly important for next-generation workspaces and Internet of Things (IoT) ecosystems.

---

Cisco Multigigabit technology offers significant benefits for a diverse range of speeds, cable types, and PoE power. The benefits can be grouped into three different areas:

- **Multiple speeds:** Cisco Multigigabit technology supports autonegotiation of multiple speeds on switch ports. The supported speeds are 100 Mbps, 1 Gbps, 2.5 Gbps, and 5 Gbps on Cat 5e cable and up to 10 Gbps over Cat 6a cabling.
- **Cable type:** The technology supports a wide range of cable types, including Cat 5e, Cat 6, and Cat 6a or above.
- **PoE power:** The technology supports PoE, PoE+, and UPOE for all the supported speeds and cable types.

For more information, visit <http://www.cisco.com/c/en/us/solutions/enterprise-networks/catalyst-multigigabit-switching/index.html>.

## Benefits

### Converged Wired plus Wireless Access

The Cisco Catalyst 3850 is the first stackable access switching platform that enables wired plus wireless services on a single Cisco IOS XE Software-based platform. With this, Cisco has pioneered a host of rich capabilities such as high availability based on stateful switchover (SSO) on stacking, granular QoS, security, and Flexible Netflow (FNF) across wired and wireless in a seamless fashion. Also, the wired plus wireless features are bundled into a single Cisco IOS Software image, which reduces the number of software images that users have to qualify/certify before enabling them in their network. The single console port for command-line interface (CLI) management reduces the number of touch points to manage for wired plus wireless services, thereby reducing network complexity, simplifying network operations, and lowering the TCO to manage the infrastructure.

Converged wired plus wireless not only improves wireless bandwidth across the network but also the scale of wireless deployment. Each 48-port Cisco Catalyst 3850 provides 40 Gbps of wireless throughput (20 Gbps on the 24-port/12-port models). This wireless capacity increases with the number of members in the stack. This makes sure that the network can scale with current wireless bandwidth requirements, as dictated by IEEE 802.11n-based access points and with future wireless standards such as IEEE 802.11ac. Additionally, the Cisco Catalyst 3850 distributes the wireless controller functions to achieve better scalability. Each Cisco Catalyst 3850 switch/stack can operate as the wireless controller in two modes (Figure 8):

- **Mobility agent (MA):** This is the default mode in which a Cisco Catalyst 3850 switch ships. In this mode the switch is capable of terminating the CAPWAP tunnels from the access points and providing wireless connectivity to wireless clients. Maintaining wireless client databases and configuring and enforcing security and QoS policies for wireless clients and access points can be enforced in this mode. No additional license on top of IP Base is required to operate in the mobility agent mode.
- **Mobility controller (MC):** In this mode, the Cisco Catalyst 3850 switch can perform all the mobility agent tasks in addition to mobility coordination, radio resource management (RRM), and Cisco CleanAir<sup>®</sup> coordination within a mobility subdomain. The mobility controller mode can be enabled on the switch CLI. IP Base license level is required when the Cisco Catalyst 3850 switch is acting as the mobility controller. A centrally located Cisco 5508 Wireless LAN Controller (WLC 5508), Cisco Wireless Services Module 2 (WiSM2) (when running AireOS Version 7.3), and Wireless LAN Controller 5760 can also perform this role for larger deployments.

With mobility agents located in the wiring closets providing 40 Gbps of wireless per 48-port Gigabit Ethernet RJ45 switch ( $n \times 40$  Gbps for a stack of  $n$  switches) and mobility controllers managing some of the central wireless functions, the converged access-based wireless deployment provides best-in-class scalability for wireless and significantly improved wireless throughput.

**Figure 8.** Mobility Controller (MC) and Mobility Agent (MA)

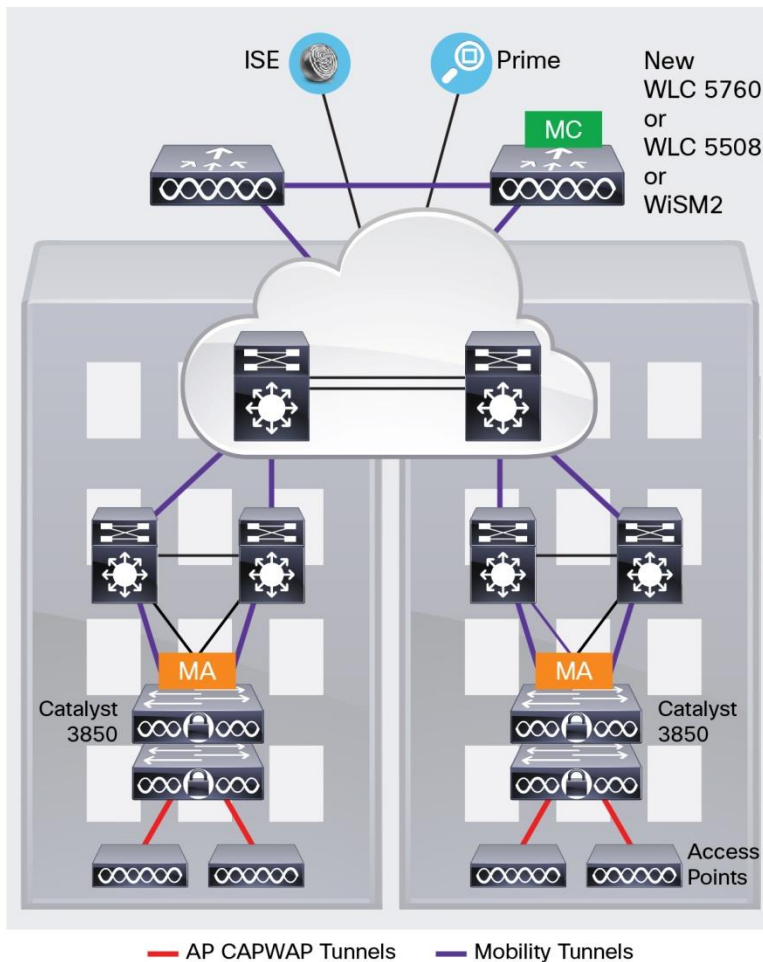

For more information about Converged Wired plus Wireless Access, refer to the Q&A document here:

<http://www.cisco.com/c/dam/en/us/products/collateral/switches/catalyst-3850-series-switches/cisco-catalyst-3850-series-switches-faq.pdf>.

## Distributed Intelligent Services

### Flexible NetFlow (FNF)

Full visibility into the wired plus wireless traffic is achieved because of the access point Control and Provisioning of Wireless Access Points (CAPWAP) tunnel termination on the switch. This helps identify users and user traffic flows in order to identify potential attackers and take corrective action at the access layer before the attack penetrates further into the network. This is achieved using FNF, which monitors every single flow entering and exiting the switch stack for wired and wireless users. It also helps identify the top wired/wireless talkers and enforce appropriate bandwidth provisioning policies.

## QoS

The Cisco Catalyst 3850 switch has advanced wired plus wireless QoS capabilities. It uses the Cisco modular QoS command line interface (MQC). The switch manages wireless bandwidth using unprecedented hierarchical bandwidth management starting at the per-access-point level and drilling further down to per-radio, per-service set identification (SSID), and per-user levels. This helps manage and prioritize available bandwidth between various radios and various SSIDs (enterprise, guest, and so on) within each radio on a percentage basis. The switch is also capable of automatically allocating equal bandwidth among the connected users within a given SSID. This makes sure that all users within a given SSID get a fair share of the available bandwidth while being connected to the network. The UADP ASIC enables the hierarchical bandwidth management and fair sharing of bandwidth, thereby providing hardware-based QoS for optimized performance at line-rate traffic.

In addition to these capabilities, the switch is able to do class of service (CoS) or differentiated services code point (DSCP) based queuing, policing, shaping, and marking of wired plus wireless traffic. This enables users to create common policies that can be used across wired plus wireless traffic. The Cisco Catalyst 3850 also supports downloadable policy names from the Cisco Identity Services Engine (ISE) when a user successfully authenticates to the network using the ISE.

## Security

The Cisco Catalyst 3850 provides a rich set of security features for wired plus wireless users. Features such as IEEE 802.1x, port security, Dynamic Host Configuration Protocol (DHCP) Snooping and Guard, Dynamic ARP Inspection, RA Guard, IP Source Guard, control plane protection (CoPP), wireless intrusion prevention systems (WIPs), and so on enable protection against unauthorized users and attackers. With a variety of wired plus wireless users connecting to the network, the switch supports session-aware networking, in which each device connected to the network is identified as one session, and unique access control lists (ACLs) and/or QoS policies can be defined and applied using the ISE for each of these sessions, providing better control on the devices connecting to the network.

## Resiliency

### **Cisco StackWise-480 Technology**

Cisco StackWise-480 technology is built on the highly successful industry-leading StackWise<sup>®</sup> technology, which is a premium stacking architecture<sup>8</sup>. StackWise-480 has a stack bandwidth of 480 Gbps. StackWise - 480 uses Cisco IOS Software SSO for providing resiliency within the stack. The stack behaves as a single switching unit that is managed by an “active” switch elected by the member switches.

The active switch automatically elects a standby switch within the stack. The active switch creates and updates all the switching/routing/wireless information and constantly synchronizes that information with the standby switch. If the active switch fails, the standby switch assumes the role of the active switch and continues to keep the stack operational. Access points continue to remain connected during an active-to-standby switchover.

A working stack can accept new members or delete old ones without service interruption. StackWise-480 creates a highly resilient single unified system of up to nine switches, providing simplified management using a single IP address, single Telnet session, single CLI, autoversion checking, autoupgrading, autoconfiguration, and more. StackWise-480 also enables local switching in Cisco Catalyst 3850 Series Switches.

---

<sup>8</sup> StackWise and StackPower technologies are not supported on the 48-port SFP+ switch model.



## Cisco StackPower Technology

The Cisco Catalyst 3850 Series uses the Cisco StackPower<sup>9</sup> technology present on the Cisco Catalyst 3850 Series. StackPower is an innovative power interconnect system that allows the power supplies in a stack to be shared as a common resource among all the switches. Cisco StackPower unifies the individual power supplies installed in the switches and creates a pool of power, directing that power where it is needed. Up to four switches<sup>10</sup> can be configured in a StackPower stack with the special connector at the back of the switch using the StackPower cable, which is different than the StackWise-480 cables. (See Figure 9.)

**Figure 9.** StackWise-480 and StackPower Connectors



StackPower can be deployed in either power-sharing mode or redundancy mode. In power-sharing mode, the power of all the power supplies in the stack is aggregated and distributed among the switches in the stack. In redundant mode, when the total power budget of the stack is calculated, the wattage of the largest power supply is not included. That power is held in reserve and used to maintain power to switches and attached devices when one power supply fails, enabling the network to operate without interruption. Following the failure of one power supply, the StackPower mode becomes power sharing.

StackPower allows customers to simply add one extra power supply in any switch of the stack and either provide power redundancy for any of the stack members or simply add more power to the shared pool. StackPower eliminates the need for an external redundant power system or installation of dual power supplies in all the stack members. StackPower is available in LAN Base license level (or higher). For LAN Base, cables need to be purchased separately.

## Foundation for Open Network Environment

The heart of the Cisco Catalyst 3850 is the UADP ASIC with programmability for future features and intelligence with investment protection. The new ASIC provides the foundation for converged APIs across wired and wireless, Cisco Open Network Environment, software-defined networking (SDN) readiness and OnePK SDK through software updates over the product lifetime.

<sup>9</sup> Stackpower is not supported on the 48-port 10G SFP+ switch model.

<sup>10</sup> Up to nine switches are supported in a star configuration with XPS-2200.



## Software Features and Services on Cisco Catalyst 3850 Series Switches

Software services supported on the Cisco Catalyst 3850 Series Switches can be classified into five broad categories:

- Ease of operations
- Advanced security features
- Resiliency
- Application visibility and control
- Audio Video Bridging

### Ease of Operations

The Cisco Catalyst 3850 helps reduce the operating costs through:

- Cisco Catalyst Smart Operations
- Easy-to-use deployment and control features
- Efficient switch operations
- Network management tools

### Cisco Catalyst Smart Operations

Cisco Catalyst Smart Operations are a comprehensive set of capabilities that simplify LAN deployment, configuration, and troubleshooting. In addition to adaptive, always-on technologies such as StackWise-480 and StackPower, Cisco Catalyst Smart Operations enable zero-touch installation and replacement of switches, fast upgrade, and ease of troubleshooting with reduced operational cost. Cisco Catalyst Smart Operations are a set of features that includes Smart Install, Auto Smartports, Smart Configuration and Smart Troubleshooting to enhance operational excellence:

- Cisco Smart Install is a transparent plug-and-play technology to configure the Cisco IOS Software image and switch configuration without user intervention. Smart Install utilizes dynamic IP address allocation and the assistance of other switches to facilitate installation, providing transparent network plug and play.
- Cisco Auto Smartports provide automatic configuration as devices connect to the switch port, allowing autodetection and plug and play of the device onto the network.
- Cisco Smart Troubleshooting is an extensive array of debug diagnostic commands and system health checks within the switch, including Generic Online Diagnostics (GOLD) and Onboard Failure Logging (OBFL).
- Embedded Event Manager (EEM) is a powerful and flexible feature that provides real-time network event detection and onboard automation. Using EEM, customers can adapt the behavior of their network devices to align with their business needs. This feature requires the IP Base feature set.

### Easy-to-Use Deployment and Control Features

- User experience:
  - IP service-level agreements (SLAs) enable customers to assure new business-critical IP applications, as well as IP services that utilize data, voice, and video, in an IP network. This feature requires the IP Services feature set.
  - DHCP autoconfiguration of multiple switches through a boot server eases switch deployment.

- Automatic QoS (AutoQoS) simplifies QoS configuration in voice over IP (VoIP) networks by issuing interface and global switch commands to detect Cisco IP phones, classify traffic, and help enable egress queue configuration.
- Autonegotiation on all ports automatically selects half- or full-duplex transmission mode to optimize bandwidth.
- Automatic media-dependent interface crossover (MDIX) automatically adjusts transmit and receive pairs if an incorrect cable type (crossover or straight through) is installed.
- AV Bridging provides reliable time synchronized transmission with no pops or clicks or video dropouts.
- Simplified configuration and connectivity:
  - Dynamic Trunking Protocol (DTP) facilitates dynamic trunk configuration across all switch ports.
  - Port Aggregation Protocol (PAgP) automates the creation of Cisco Fast EtherChannel groups or Gigabit EtherChannel groups to link to another switch, router, or server.
  - Link Aggregation Control Protocol (LACP) allows the creation of Ethernet channeling with devices that conform to IEEE 802.3ad. This feature is similar to Cisco EtherChannel technology and PAgP.
  - Unidirectional Link Detection Protocol (UDLD) and aggressive UDLD allow unidirectional links caused by incorrect fiber-optic wiring or port faults to be detected and disabled on fiber-optic interfaces.
  - Cisco VLAN Trunking Protocol (VTP) Version 3 supports dynamic VLANs and dynamic trunk configuration across all switches.
  - AV Bridging provides reliable A/V streaming without the need for the installer to perform extensive hand tuning of the network.
- Efficient switch operation:
  - Switching database manager (SDM) templates, VLAN template (specific to LAN Base license level), and advanced template allow the administrator to automatically optimize the ternary content-addressable memory (TCAM) allocation to the desired features based on deployment-specific requirements.
  - Local proxy Address Resolution Protocol (ARP) works in conjunction with private VLAN edge to minimize broadcasts and maximize available bandwidth.
  - Stacking master configuration management with Cisco StackWise-480 technology helps make sure that all switches are automatically upgraded when the master switch receives a new software version. Automatic software version checking and updating help ensure that all stack members have the same software version.
  - Trivial File Transfer Protocol (TFTP) reduces the cost of administering software upgrades by downloading from a centralized location.
  - Network Timing Protocol (NTP) provides an accurate and consistent timestamp to all intranet switches.
- Multicast:
  - Optimized multicast for wired plus wireless: Cisco Catalyst 3850 offers greater multicast efficiency by receiving only one multicast stream and replicating it for all connected wired plus wireless devices connected to that switch.
  - Internet Group Management Protocol (IGMP) v1, v2, v3 snooping for IPv4: multicast listener discovery (MLD) v1 and v2 snooping provides fast client joins and leaves of multicast streams and limits bandwidth-intensive video traffic to only the requestors.

- **Monitoring:**
  - Remote Switch Port Analyzer (RSPAN) allows administrators to remotely monitor ports in a Layer 2 switch network from any other switch in the same network.
  - For enhanced traffic management, monitoring, and analysis, the Embedded Remote Monitoring (RMON) software agent supports four RMON groups (history, statistics, alarms, and events).
  - Layer 2 traceroute eases troubleshooting by identifying the physical path that a packet takes from source to destination.
  - Wireless RF management provides both real-time and historical information about RF interference affecting network performance across controllers using systemwide Cisco CleanAir technology integration.

### **Efficient Switch Operation**

Cisco Catalyst 3850 Series Switches, designed and engineered by Cisco, provide optimum power-saving, EEE (on RJ45 ports), low-power operations for industry best-in-class power management and power consumption capabilities. The Cisco Catalyst 3850 ports are capable of reduced power modes so that ports not in use can move into a lower power utilization state. Other efficient switch operation features are:

- Cisco Discovery Protocol Version 2 allows the Cisco Catalyst 3850 Series Switches to negotiate a more granular power setting when connecting to a Cisco powered device such as IP phones or access points than what is provided by IEEE classification.
- Per-port power consumption command allows customers to specify maximum power setting on an individual port. Per-port PoE power sensing measures actual power being drawn, enabling more intelligent control of powered devices.
- The PoE MIB provides proactive visibility into power usage and allows customers to set different power-level thresholds.

### **Environmental Responsibility**

Organizations may choose to turn off access point radios to reduce power consumption during off-peak hours. The integrated wireless LAN controller avoids the deployment of additional devices in the network.

### **Network Management Tools**

The Cisco Catalyst 3850 Series Switches offer both a superior CLI for detailed configuration and Cisco Prime™ infrastructure for unified wired plus wireless management. Prime infrastructure provides day 0 and ongoing provisioning, ongoing monitoring and maintenance, configuration templates, and device and user 360-degree views and serves as the FNF collector for user traffic views using the Prime Assurance Manager module.

For detailed information about Cisco Prime infrastructure, go to <http://www.cisco.com/en/US/products/ps12239/index.html>.

### **Advanced Security Features**

Cisco Catalyst 3850 Series Switches support advanced security features including but not limited to:

- Protection against attackers:
  - Port security secures the access to an access or trunk port based on MAC address. It limits the number of learned MAC addresses to deny MAC address flooding.

- DHCP snooping prevents malicious users from spoofing a DHCP server and sending out bogus addresses. This feature is used by other primary security features to prevent a number of other attacks such as ARP poisoning.
- Dynamic ARP inspection (DAI) helps ensure user integrity by preventing malicious users from exploiting the insecure nature of ARP.
- IP source guard prevents a malicious user from spoofing (that is, taking over) another user's IP address by creating a binding table between the client's IP and MAC address, port, and VLAN, and by using it to selectively block bogus packets.
- The Unicast Reverse Path Forwarding (uRPF) feature helps mitigate problems caused by the introduction of malformed or forged (spoofed) IP source addresses into a network by discarding IP packets that lack a verifiable IP source address.
- Bidirectional data support on a SPAN port allows the Cisco intrusion detection system (IDS) to take action when an intruder is detected.
- User authentication:
  - Flexible authentication that supports multiple authentication mechanisms, including 802.1X, MAC authentication bypass, and web authentication using a single, consistent configuration.
  - RADIUS change of authorization and downloadable calls for comprehensive policy management capabilities.
  - Private VLAN edge restricts traffic between hosts in a switch by segregating traffic at Layer 2, turning a broadcast segment into a nonbroadcast multiaccess like segment. Private VLAN edge provides security and isolation between switch ports, which helps ensure that users cannot snoop on other users' traffic.
  - Multidomain authentication allows an IP phone and a PC to authenticate on the same switch port while placing them on appropriate voice and data VLAN.
  - MAC address notification allows administrators to be notified of users added to or removed from the network.
  - Mobility and security for secure, reliable wireless connectivity and consistent end-user experience. Increased network availability through proactive blocking of known threats.
  - IGMP filtering provides multicast authentication by filtering out nonsubscribers and limits the number of concurrent multicast streams available per port.
- ACLs:
  - Cisco security VLAN ACLs on all VLANs prevent unauthorized data flows from being bridged within VLANs.
  - Cisco standard and extended IP security router ACLs define security policies on routed interfaces for control-plane and data-plane traffic. IPv6 ACLs can be applied to filter IPv6 traffic.
  - Port-based ACLs for Layer 2 interfaces allow security policies to be applied on individual switch ports.
- Device access:
  - Secure Shell (SSH) Protocol, Kerberos, and Simple Network Management Protocol Version 3 (SNMPv3) provide network security by encrypting administrator traffic during Telnet and SNMP sessions. SSH Protocol, Kerberos, and the cryptographic version of SNMPv3 require a special cryptographic software image because of U.S. export restrictions.

- TACACS+ and RADIUS authentication facilitates centralized control of the switch and restricts unauthorized users from altering the configuration.
- Multilevel security on console access prevents unauthorized users from altering the switch configuration.
- Bridge protocol data unit (BPDU) Guard shuts down Spanning Tree PortFast-enabled interfaces when BPDUs are received to avoid accidental topology loops.
- Spanning Tree Root Guard (STRG) prevents edge devices not in the network administrator's control from becoming Spanning Tree Protocol root nodes.
- Wireless end-to-end security offers CAPWAP-compliant DTLS encryption to make sure of encryption between access points and controllers across remote WAN/LAN links.

## Resiliency

Borderless networks enable enterprise mobility and business-grade video services. Industry's first unified network (wired plus wireless) location services enable tracking of mobile assets and the users of those assets for both wired plus wireless devices. The true borderless experience is enabled by the following feature sets in the Cisco Catalyst 3850 Series Switches:

- High availability
- High-performance IP routing
- Superior QoS

## High Availability

In addition to StackWise-480 and StackPower<sup>11</sup>, the Cisco Catalyst 3850 Series supports high-availability features including but not limited to the following:

- Cross-Stack EtherChannel provides the ability to configure Cisco EtherChannel technology across different members of the stack for high resiliency.
- Flexlink provides link redundancy with convergence time less than 100ms.
- IEEE 802.1s Multiple Spanning Tree Protocol (MSTP) provides rapid spanning-tree convergence independent of spanning-tree timers and also offers the benefit of Layer 2 load balancing and distributed processing.
- Per-VLAN Rapid Spanning Tree (PVRST+) allows rapid spanning-tree (IEEE 802.1w) reconvergence on a per-VLAN spanning-tree basis, providing simpler configuration than MSTP. In both MSTP and PVRST+ modes, stacked units behave as a single spanning-tree node.
- Switch-port autorecovery ("err-disable" recovery) automatically attempts to reactivate a link that is disabled because of a network error.

<sup>11</sup> Stackpower is not supported on the 48-port 10G SFP+ switch model

<sup>11</sup> Stackpower is not supported on the 48-port 10G SFP+ switch model

## High-Performance IP Routing

The Cisco Express Forwarding hardware routing architecture delivers extremely high-performance IP routing in the Cisco Catalyst 3850 Series Switches:

- IP unicast routing protocols (static, Routing Information Protocol Version 1 [RIPv1], and RIPv2, RIPv2, Enhanced Interior Gateway Routing Protocol [EIGRP] stub) are supported for small-network routing applications with the IP Base feature set. Limited static routing with the LAN Base feature set. Equal-cost routing facilitates Layer 3 load balancing and redundancy across the stack.
- Advanced IP unicast routing protocols (Open Shortest Path First [OSPF], EIGRP, Border Gateway Protocol Version 4 [BGPv4], and Intermediate System-to-Intermediate System Version 4 [IS-ISv4]) are supported for load balancing and constructing scalable LANs. IPv6 routing (OSPFv3, EIGRPv6) is supported in hardware for maximum performance. OSPF for routed access is included in the IP Base image. The IP Services feature set is required for full OSPF, EIGRP, BGPv4, and IS-ISv4.
- Policy-based routing (PBR) allows superior control by facilitating flow redirection regardless of the routing protocol configured. The IP Base feature set is required for PBR. Virtual routing and forwarding (VRF)-Lite enables a service provider to support two or more VPNs, with overlapping IP addresses. The IP Services feature set is required for VRF-Lite.
- Protocol-independent multicast (PIM) for IP multicast routing is supported, including PIM sparse mode (PIM-SM), PIM dense mode (PIM-DM), PIM sparse-dense mode, and source-specific multicast (SSM). The IP Services feature set is required.
- IPv6 addressing is supported on interfaces with appropriate show commands for monitoring and troubleshooting.

## Superior QoS

The Cisco Catalyst 3850 Series offers Gigabit Ethernet speed with intelligent services that keep traffic flowing smoothly, even at 10 times the normal network speed. Industry-leading mechanisms for cross-stack marking, classification, and scheduling deliver superior performance for data, voice, and video traffic, all at wire speed.

The following are some of the QoS features supported in the Cisco Catalyst 3850 Series Switches:

- Granular wireless bandwidth management and fair sharing use Cisco's proven Cisco IOS Software and UADP ASIC technology to provide hierarchical bandwidth management at line rate (per access point, per radio, per SSID, per client-based policies). Fair sharing across the users within an SSID makes sure that no single user is starved because of other heavy-hitting users. Fair sharing is automatically enabled for wireless at user level as well as SSID level.
- 802.1p CoS and DSCP field classification is provided, using marking and reclassification on a per-packet basis by source and destination IP address, MAC address, or Layer 4 Transmission Control Protocol/User Datagram Protocol (TCP/UDP) port number.
- Shaped round robin (SRR) scheduling helps ensure differential prioritization of packet flows by intelligently servicing the ingress queues and egress queues. Weighted tail drop (WTD) provides congestion avoidance at the ingress and egress queues before a disruption occurs. Strict priority queuing helps ensure that the highest priority packets are serviced ahead of all other traffic.
- The Cisco committed information rate (CIR) function provides bandwidth in increments as low as 8 Kbps.

- Rate limiting is provided based on source and destination IP address, source and destination MAC address, Layer 4 TCP/UDP information, or any combination of these fields, using QoS ACLs (IP ACLs or MAC ACLs), class maps, and policy maps.
- Eight egress queues per port for wired traffic and four egress queues for wireless help enable differentiated management of different traffic types across the stack for wired traffic. Up to 2000 aggregate policers are available per switch.

## Application Visibility and Control Using Flexible NetFlow

Cisco IOS Software FNF is the next generation in flow visibility technology, allowing optimization of the network infrastructure, reducing operation costs, and improving capacity planning and security incident detection with increased flexibility and scalability. The Cisco Catalyst 3850 provides optimized application visibility with FNF across wired plus wireless. The switch is capable of up to 48,000 flow entries on 48-port models and up to 24,000 flow entries on 12-port and 24-port models across wired plus wireless. With UADP ASIC, Cisco Catalyst 3850 delivers next-generation flow technology with unprecedented flexibility and comprehensive visibility extending from Layer 2 (MAC and VLAN) to Layer 4 (TCP/UDP) flags and so on across wired plus wireless traffic. The Cisco Catalyst 3850 switch is Medianet capable to provide visibility and troubleshooting capabilities across wired plus wireless video traffic. Specific Medianet features will be enabled in future software updates.

The flow data collected by FNF can be exported to an external collector for analysis and reporting or tracked by the EEM. The Cisco Catalyst 3850 enables powerful on-box and customizable event correlation and policy actions with EEM, allowing the switches to trigger customized event alarms or policy actions when the predefined condition is met. With no external appliance required, customers are able to use existing infrastructure to perform traffic monitoring, making traffic analysis economical even on a large IP network.

Details about Cisco FNF are available at

[http://www.cisco.com/en/US/prod/collateral/iosswrel/ps6537/ps6555/ps6601/ps6965/product\\_data\\_sheet0900aecd804b590b.html](http://www.cisco.com/en/US/prod/collateral/iosswrel/ps6537/ps6555/ps6601/ps6965/product_data_sheet0900aecd804b590b.html).

High-performance video over wireless integrates Cisco VideoStream technology to optimize the delivery of video applications across the WLAN.

Wired plus wireless IP telephony supports [unified communications](#) for improved collaboration through messaging, presence, and conferencing and supports all Cisco Unified Communications wireless IP phones for cost-effective, real-time voice service.

## Audio Video Bridging

With Cisco IOS® XE Software Release 16.3, Cisco Catalyst 3850 MultiGigabit and 3850 10G SFP+ now support the IEEE 802.1 AVB standard. This standard provided the means for highly reliable delivery of low-latency, time-synchronized AV streaming services through Layer 2 Ethernet networks. The standard also makes it easier to integrate new services and for AV equipment from different vendors to interoperate. Whether the AV endpoint connections are analog or are inflexible digital one to one, the network transport enables many-to-many transparent plug-and-play connections for multiple AV endpoints.

---

**Benefits:**

- Improves quality of experience by lowering jitter and latency for time-synchronized delivery of high-quality AV
- Provides scalability of applications across networked deployments, including expansive and complex AV infrastructure
- Lowers total cost of ownership (TCO) with reduced cabling (lowers CapEx) and no license fees (lowers OpEx)

For details about AVB, check <http://www.cisco.com/go/AVB>.

## Deployment Options

### Campus

In a campus-type deployment, operating the Cisco Catalyst 3850 in the mobility agent mode and centralizing the mobility controller functionality in a WLC 5760, WLC 5508, or WiSM2 helps achieve better scalability and performance. The Cisco Catalyst 3850 provides CAPWAP termination for access points, uniform policy enforcement for wireless clients, better wireless bandwidth, and uniform Cisco IOS Software-based configuration and monitoring for wired plus wireless features. The mobility controller provides central mobility, RRM, and CleanAir coordination.

Backward compatibility with traditional centralized wireless deployment mode on the WLC 5508, WiSM2, and WLC 5760 helps ensure that customers can migrate to the Cisco Catalyst 3850-based converged access approach in phases, providing a continued controller for existing access points. This migration also provides investment protection on the existing wireless controller infrastructure. A phased adoption of the new Cisco Catalyst 3850 helps ensure that migration to the converged access mode of wireless is seamless. Figure 10 shows a Cisco Catalyst 3850 in the campus type deployment.



**Figure 10.** Mobility Controller (MC) and Mobility Agent (MA)

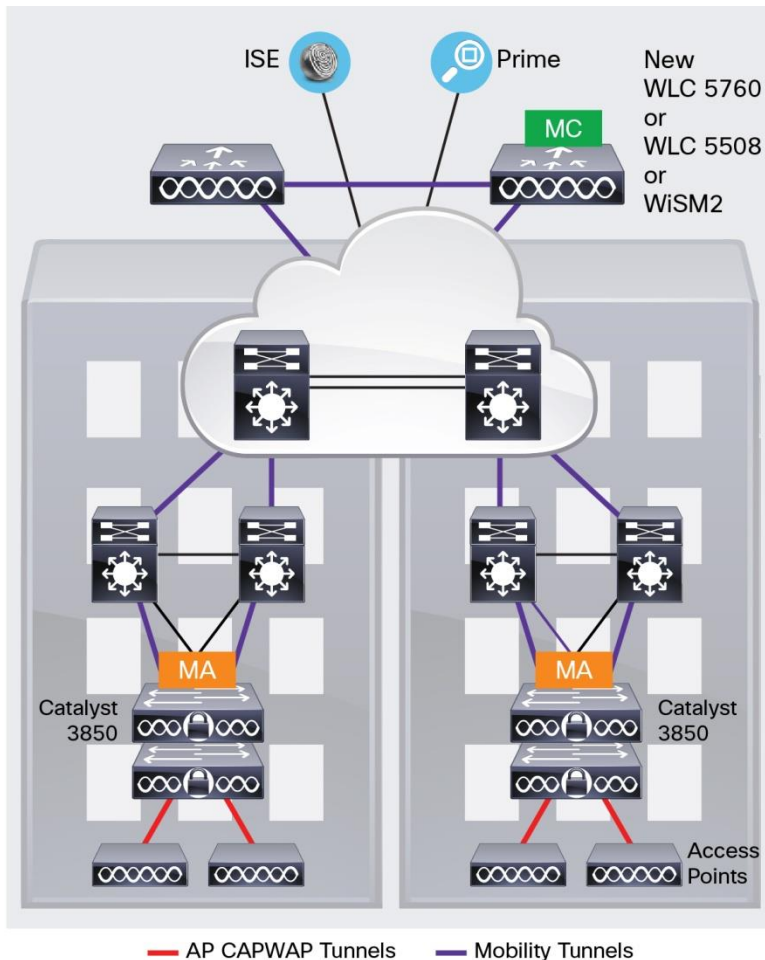

### Branch

The Cisco Catalyst 3850 is optimized for branch deployments when it operates in mobility controller mode. In this mode, not only can the switch terminate CAPWAP tunnels from the access points and provide client connectivity, it can also manage mobility within the branch. This eliminates the need for a local controller in every branch in addition to the access-layer switches. Also, complete visibility into the wired plus wireless traffic means that the WAN router can prioritize the right wired plus wireless traffic in and out of the branch. Figure 11 shows a Cisco Catalyst 3850 in a branch access type deployment.

**Figure 11.** Deploying the Cisco Catalyst 3850 in the Branch Access

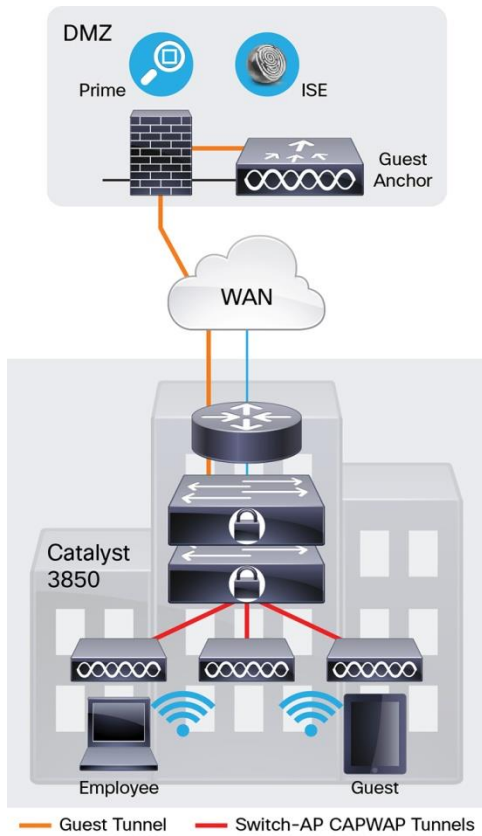

The new 12-port and 24-port SFP+ or SFP-based Cisco Catalyst 3850 models as well as the nonstackable 48-port SFP+ model can also be used in the branch to aggregate traffic from smaller access switches through fiber links for more secure and EMI-sensitive deployments (Figure 12).

**Figure 12.** Deploying Mixed Copper and Fiber Connections with a Cisco Catalyst 3850 Stack in the Branch

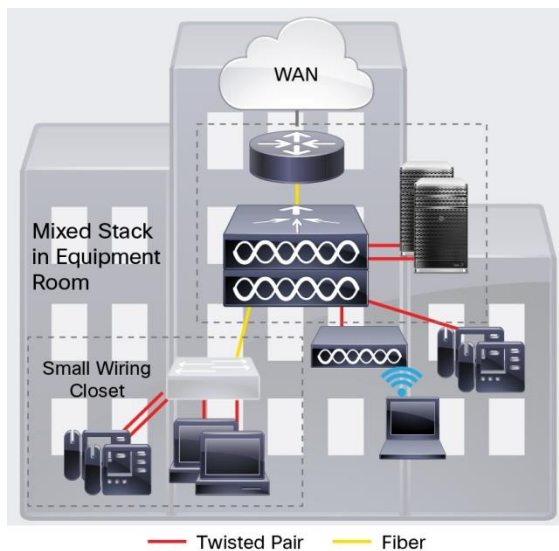

## Cisco Catalyst 3850 Series Specifications

### Switch Performance

Table 9 shows Cisco Catalyst 3850 Series Switches performance specifications.

**Table 9.** Cisco Catalyst 3850 Performance Specifications

Performance Numbers for All Switch Models	
<b>Switching capacity</b>	176 Gbps on 48-port Gigabit Ethernet model 92 Gbps on 24-port Gigabit Ethernet model 68 Gbps on 12-port Gigabit Ethernet model 640 Gbps on 24-port Multigigabit Ethernet model <sup>*</sup> 472 Gbps on 48-port Multigigabit Ethernet model 1280 Gbps on 48-port 10 Gigabit Ethernet SFP+ model <sup>*</sup> 640 Gbps (packet size >= 80 bytes) on 24-port 10 Gigabit Ethernet SFP+ model <sup>*</sup> 320 Gbps on 12-port 10 Gigabit Ethernet SFP+ model <sup>*</sup> <sup>*</sup> Packet size >= 80 bytes
<b>Stacking bandwidth</b>	480 Gbps
<b>Total number of MAC addresses</b>	32,000
<b>Total number of IPv4 routes (ARP plus learned routes)</b>	24,000
<b>FNF entries</b>	48,000 flow on 48-port Gigabit Ethernet models 24,000 flows on 12-port and 24-port Gigabit Ethernet models 96,000 flows on 48-port 10 Gigabit Ethernet SFP+ model 48,000 flows on 24-port 10 Gigabit Ethernet SFP+ model 24,000 flows on 12-port 10 Gigabit Ethernet SFP+ model
<b>DRAM</b>	4 GB (8 GB on 48-port SFP+ model)
<b>Flash</b>	2 GB (4 GB on 12-port and 24-port SFP+ models, 8 GB on 48-port SFP+ model)
<b>VLAN IDs</b>	4,000
<b>Total switched virtual interfaces (SVIs)</b>	1,000
<b>Jumbo frame</b>	9198 bytes
<b>Total routed ports per 3850 stack</b>	208
<b>Wireless</b>	
<b>Number of access points per switch/stack</b>	100
<b>Number of wireless clients per switch/stack</b>	2000
<b>Total number of WLANs per switch</b>	64
<b>Wireless bandwidth per switch</b>	Up to 40 Gbps on 48-port Gigabit Ethernet model Up to 20 Gbps on 24-port Gigabit Ethernet model
<b>Supported Aironet access point series</b>	3600, 3500, 2600, 1600, 1260, 1140, 1040
<b>Forwarding Rate of Switch Models (with 2 x 10 Gigabit + 2 x 1 Gigabit Ethernet uplinks for 12-Port and 24-Port Models and 4 x 10 Gigabit Ethernet Uplinks for 48-Port Models)</b>	
Model	Forwarding Rate
WS-C3850-12S	50.5 Mpps
WS-C3850-24T	68.4 Mpps
WS-C3850-24P	
WS-C3850-24S	
WS-C3850-48T	130.95 Mpps
WS-C3850-48P	
WS-C3850-48F	
WS-C3850-24XU	500 Mpps (80B packets)
WS-C3850-12X48U	460 Mpps (64B packets)
WS-C3850-12XS	227.28 Mpps

Performance Numbers for All Switch Models	
WS-C3850-24XS	454.55 Mpps
WS-C3850-48XS	909 Mpps

## Dimensions, Weight, Acoustic, Mean Time between Failure, and Environmental Range Specifications for Cisco Catalyst 3850 Series Switches

Table 10 shows dimensions, weight, acoustic, mean time between failure (MTBF), and environmental range. Weight does not include an uplink FRU. Weight includes the chassis assembly as it is shipped (with fans), one power supply and, and one power supply slot blank.

**Table 10.** Dimensions, Weight, Acoustic, MTBF, and Environmental Range<sup>12</sup>

Dimensions (H x W x D)	Inches	Centimeters
WS-C3850-12S	1.75 x 17.5 x 17.7	4.45 x 44.5 x 45.0
WS-C3850-24S		
WS-C3850-24T		
WS-C3850-24P		
WS-C3850-48T		
WS-C3850-48P		
WS-C3850-48F	1.75 x 17.5 x 19.2	4.45 x 44.5 x 48.8
WS-C3850-48U		
WS-C3850-24U		
WS-C3850-24XU		
WS-C3850-12X48U		
WS-C3850-12XS	1.75 x 17.5 x 17.7	4.45 X 44.5 x 45.0
WS-C3850-24XS		
WS-C3850-48XS	1.75 x 17.5 x 20.1	4.45 X 44.5 x 51.1
Weight	Pounds	Kilograms
WS-C3850-12S	15.48	7.02
WS-C3850-24S	15.5	7.03
WS-C3850-24T	15.9	7.2
WS-C3850-24P	16.3	7.4
WS-C3850-24U	16.5	7.5
WS-C3850-48T	17.0	7.7
WS-C3850-48P	17.4	7.9
WS-C3850-48F	17.6	8.0
WS-C3850-48U	17.6	8.0
WS-C3850-24XU	17.6	8.0
WS-C3850-12X48U	17.6	8.0
WS-C3850-12XS	12.9	5.8
WS-C3850-24XS	13.5	6.1
WS-C3850-48XS	16.42	7.45
C3850-NM-4-1G	0.66	0.30
C3850-NM-2-10G	0.71	0.32

<sup>12</sup> Additional information about the 48-port SFP+ model will be provided at time of shipment.

C3850-NM-4-10G	0.75	0.34
C3850-NM-8-10G	0.74	0.34
C3850-NM-2-40G	0.62	0.28
<b>MTBF Hours</b>		
WS-C3850-12S	315,840	
WS-C3850-24S	300,760	
WS-C3850-24T	303,230	
WS-C3850-24P	269,450	
WS-C3850-24U	237,310	
WS-C3850-48T	303,660	
WS-C3850-48P	241,050	
WS-C3850-48F	241,050	
WS-C3850-48U	205,110	
WS-C3850-24XU	203,150	
WS-C3850-12X48U	202,030	
WS-C3850-12XS	371,440	
WS-C3850-24XS	307,990	
WS-C3850-32XS	307,990	
WS-C3850-48XS	286,900	
PWR-C1-350WAC	580,710	
PWR-C1-715WAC	664,055	
PWR-C1-1100WAC	392,174	
PWR-C1-440WDC	469,350	
C3850-NM-4-1G	7,052,100	
C3850-NM-2-10G	4,315,970	
C3850-NM-4-10G	3,835,330	
C3850-NM-8-10G	6,544,410	
C3850-NM-2-40G	9,303,100	
<b>Environmental Ranges</b>		
<b>With AC power supply</b> <b>Operating environment and altitude</b>	<p>Normal operating temperature* and altitudes:</p> <ul style="list-style-type: none"> <li>• -5°C to +45°C, up to 5000 feet (1500m)</li> <li>• -5°C to +40°C, up to 10,000 feet (3000m)</li> </ul> <p>* Minimum ambient temperature for cold start is 32°F (0°C)</p> <p>Short-term* exceptional conditions:</p> <ul style="list-style-type: none"> <li>• -5°C to +50°C, up to 5000 feet (1500m)</li> <li>• -5°C to +45°C, up to 10,000 feet (3000m)</li> <li>• -5°C to +45°C, at sea level with single fan failure</li> </ul> <p>* Not more than following in one-year period: 96 consecutive hours, or 360 hours total, or 15 occurrences.</p>	

<b>With DC power supply</b> <b>Operating environment and altitude (NEBS)</b>	<p>Normal operating temperature and altitudes:</p> <ul style="list-style-type: none"> <li>• -5°C to +45°C, up to 6000 feet (1800m)</li> <li>• -5°C to +40°C, up to 10,000 feet (3000m)</li> <li>• -5°C to +35°C, up to 13,000 feet (4000m)</li> </ul> <p>Short-term exceptional conditions:</p> <ul style="list-style-type: none"> <li>• -5°C to +55°C, up to 6000 feet (1800m)</li> <li>• -5°C to +50°C, up to 10,000 feet (3000m)</li> <li>• -5°C to +45°C, up to 13,000 feet (4000m)</li> <li>• -5°C to +45°C, at sea level with single fan failure</li> </ul> <p>Not more than following in one-year period: 96 consecutive hours, or 360 hours total, or 15 occurrences.</p>
<b>Relative humidity</b>	10% to 95%, noncondensing
<b>Acoustic noise</b> <b>Measured per ISO 7779 and declared per ISO 9296</b> <b>Bystander positions operating to an ambient temperature of 25°C</b>	<p>With AC or DC power supply (with 24 PoE+ ports loaded):</p> <ul style="list-style-type: none"> <li>• LpA: 43dB typical, 45dB maximum</li> <li>• LwA: 5.2B typical, 5.5B maximum</li> </ul> <p>Typical: Noise emission for a typical configuration Maximum: Statistical maximum to account for variation in production</p>
<b>Storage environment</b>	<p>Temperature: -40°C to 70°C Altitude: 15,000 ft</p>
<b>Vibration</b>	<p>Operating: 0.41Grms from 3 to 500Hz with spectral break points of 0.0005 G2/Hz at 10Hz and 200Hz 5dB/octave roll off at each end.</p> <p>Nonoperating: 1.12Grms from 3 to 500Hz with spectral break points of 0.0065 G2/Hz at 10Hz and 100Hz 5dB/octave roll off at each end.</p>
<b>Shock</b>	<p>Operating: 30G, 2ms half sine Nonoperating: 55G, 10ms trapezoid</p>

## Connectors for Cisco Catalyst 3850 Series

Table 11 shows the supported connectors.

**Table 11.** Connectors

<b>Connectors and cabling</b>	<ul style="list-style-type: none"> <li>• 1000BASE-T ports: RJ-45 connectors, 4-pair Cat-5E UTP cabling</li> <li>• Multigig-T ports: RJ-45 connectors, 4-pair Cat-5E, Cat-6, Cat6A UTP cabling</li> <li>• 1000BASE-T SFP-based ports: RJ-45 connectors, 4-pair Cat-5E UTP cabling</li> <li>• 100BASE-FX, 1000BASE-SX, -LX/LH, -ZX, -BX10, DWDM and CWDM SFP transceivers: LC fiber connectors (single-mode or multimode fiber)</li> <li>• 10GBASE-SR, LR, LRM, ER, ZR, DWDM SFP+ transceivers: LC fiber connectors (single-mode or multimode fiber)</li> <li>• CX1 cable assemblies: SFP+ connector</li> <li>• Cisco StackWise-480 stacking ports: copper-based Cisco StackWise cabling</li> <li>• Cisco StackPower: Cisco proprietary power stacking cables</li> <li>• Ethernet management port: RJ-45 connectors, 4-pair Cat-5 UTP cabling</li> <li>• Management console port: RJ-45-to-DB9 cable for PC connections</li> </ul>
<b>Power connectors</b>	<ul style="list-style-type: none"> <li>• Customers can provide power to a switch by using either the internal power or StackPower from another member in the power stack. The connectors are located at the back of the switch.</li> <li>• Internal power supply connector: The internal power supply is an autoranging unit. The internal power supply supports input voltages between 100 and 240VAC. Use the supplied AC power cord to connect the AC power connector to an AC power outlet.</li> </ul>

For the latest Cisco transceiver module compatibility information, refer to

<http://www.cisco.com/c/en/us/support/interfaces-modules/transceiver-modules/products-device-support-tables-list.html>.

## Management and Standards Support for Cisco Catalyst 3850 Series Switches

Table 12 shows management and standards support for the Cisco Catalyst 3850 Series.

**Table 12.** Management and Standards Support for the Cisco Catalyst 3850 Series

Description	Specification
<b>Management</b>	BRIDGE-MIB CISCO-AUTH-FRAMEWORK-MIB CISCO-BGP4-MIB, BGP4-MIB CISCO-BRIDGE-EXT-MIB CISCO-BULK-FILE-MIB CISCO-CABLE-DIAG-MIB CISCO-CALLHOME-MIB CISCO-CEF-MIB CISCO-CIRCUIT-INTERFACE-MIB CISCO-ENTITY-VENDORTYPE-OID-MIB CISCO-CONTEXT-MAPPING-MIB CISCO-DEVICE-LOCATION-MIB CISCO-DHCP-SNOOPING-MIB CISCO-EIGRP-MIB CISCO-EMBEDDED-EVENT-MGR-MIB CISCO-ENTITY-FRU-CONTROL-MIB CISCO-ENTITY-SENSOR-MIB ENTITY-MIB CISCO-ERR-DISABLE-MIB CISCO-CONFIG-COPY-MIB CISCO-FLOW-MONITOR-MIB CISCO-FTP-CLIENT-MIB CISCO-HSRP-EXT-MIB CISCO-HSRP-MIB CISCO-IETF-ISIS-MIB CISCO-IF-EXTENSION-MIB CISCO-IGMP-FILTER-MIB CISCO-CONFIG-MAN-MIB CISCO-IP-CBR-METRICS-MIB CISCO-IPMROUTE-MIB CISCO-IP-STAT-MIB CISCO-IP-URPF-MIB CISCO-L2L3-INTERFACE-CONFIG-MIB CISCO-LAG-MIB CISCO-LICENSE-MGMT-MIB CISCO-MAC-AUTH-BYPASS-MIB CISCO-MAC-NOTIFICATION-MIB CISCO-MDI-METRICS-MIB CISCO-FLASH-MIB CISCO-OSPF-MIB CISCO-OSPF-TRAP-MIB CISCO-PAE-MIB CISCO-PAGP-MIB CISCO-PIM-MIB CISCO-PING-MIB CISCO-PORT-QOS-MIB CISCO-PORT-SECURITY-MIB CISCO-PORT-STORM-CONTROL-MIB CISCO-POWER-ETHERNET-EXT-MIB CISCO-PRIVATE-VLAN-MIB CISCO-SNMP-TARGET-EXT-MIB CISCO-STACKMAKER-MIB CISCO-MEMORY-POOL-MIB CISCO-STP-EXTENSIONS-MIB CISCO-SYSLOG-MIB CISCO-TCP-MIB CISCO-UDLDP-MIB CISCO-VLAN-IFTABLE-RELATIONSHIP-MIB CISCO-VLAN-MEMBERSHIP-MIB CISCO-VTP-MIB EtherLike-MIB HC-RMON-MIB IEEE8021-PAE-MIB IEEE8023-LAG-MIB IF-MIB IGMP-MIB IGMP-STD-MIB IP-FORWARD-MIB IP-MIB IPMROUTE-STD-MIB LLDP-EXT-MED-MIB LLDP-MIB NOTIFICATION-LOG-MIB OLD-CISCO-MEMORY-MIB CISCO-CDP-MIB POWER-ETHERNET-MIB RMON2-MIB RMON-MIB SNMP-COMMUNITY-MIB SNMP-FRAMEWORK-MIB SNMP-MPD-MIB SNMP-NOTIFICATION-MIB SNMP-PROXY-MIB SNMP-TARGET-MIB SNMP-USM-MIB SNMPv2-MIB SNMP-VIEW-BASED-ACM-MIB TCP-MIB UDP-MIB CISCO-IMAGE-MIB CISCO-STACKWISE-MIB AIRESPMACE-WIRELESS-MIB CISCO-LWAPP-IDS-MIB CISCO-LWAPP-AP-MIB CISCO-LWAPP-CCX-RM-MIB CISCO-LWAPP-CLIENT-ROAMING-MIB CISCO-LWAPP-DOT11-CCX-CLIENT-DIAG-MIB CISCO-LWAPP-DOT11-CCX-CLIENT-MIB CISCO-LWAPP-DOT11-CLIENT-CCX-REPORTS-MIB

Description	Specification	
	CISCO-PROCESS-MIB CISCO-PRODUCTS-MIB CISCO-RF-MIB CISCO-RTP-METRICS-MIB CISCO-RTTMON-MIB CISCO-SMART-INSTALL-MIB	CISCO-LWAPP-DOT11-CLIENT-MIB CISCO-LWAPP-DOT11-MIB CISCO-LWAPP-DOWNLOAD-MIB CISCO-LWAPP-LINKTEST-MIB CISCO-LWAPP-MFP-MIB CISCO-LWAPP-MOBILITY-EXT-MIB CISCO-LWAPP-QOS-MIB CISCO-LWAPP-REAP-MIB CISCO-LWAPP-ROGUE-MIB CISCO-LWAPP-RRM-MIB CISCO-LWAPP-SI-MIB CISCO-LWAPP-TSM-MIB CISCO-LWAPP-WLAN-MIB CISCO-LWAPP-WLAN-SECURITY-MIB
<b>Standards</b>	IEEE 802.1s IEEE 802.1w IEEE 802.11 IEEE 802.1x IEEE 802.1x-Rev IEEE 802.3ad IEEE 802.3af IEEE 802.3at IEEE 802.3x full duplex on 10BASE-T, 100BASE-TX, and 1000BASE-T ports IEEE 802.1D Spanning Tree Protocol IEEE 802.1p CoS prioritization IEEE 802.1Q VLAN IEEE 802.3 10BASE-T specification IEEE 802.3u 100BASE-TX specification IEEE 802.3ab 1000BASE-T specification IEEE 802.3z 1000BASE-X specification	RMON I and II standards SNMPv1, SNMPv2c, and SNMPv3

## Power Supply Specifications

Table 13 lists the power specifications for the Cisco Catalyst 3850 Series based on the kind of power supply used.

**Table 13.** Power Specifications for Cisco Catalyst 3850 Series

Description	Specification			
	PWR-C1-1100WAC	PWR-C1-715WAC	PWR-C1-350WAC	PWR-C1-440WDC
<b>Power supply rated maximum</b>	1100W	715W	350W	440W
<b>Total output BTU (Note: 1000 BTU/hr = 293W)</b>	3793 BTU/hr, 1100W	2465 BTU/hr, 715W	1207BTU/hr, 350W	1517BTU/hr, 440W
<b>Input-voltage range and frequency</b>	115-240VAC, 50-60 Hz	100-240VAC, 50-60 Hz	100-240VAC, 50-60 Hz	-36VDC to -72VDC
<b>Input current</b>	12-6A	10-5A	4-2A	<8A at -72VDC <16A at -36VDC
<b>Output ratings</b>	-56V at 19.64A	-56V at 12.8A	-56V at 6.25A	-56V at 7.86A
<b>Output holdup time</b>	10 ms minimum at 102.5VAC	16.7 ms minimum at 100VAC	16.7 ms minimum at 100VAC	> 2ms at -48VDC
<b>Power-supply input receptacles</b>	IEC 320-C16 (IEC60320-C16)	IEC 320-C16 (IEC60320-C16)	IEC 320-C16 (IEC60320-C16)	Terminal strip
<b>Power cord rating</b>	13A	13A	10A	20A at 100VDC



Description	Specification			
<b>Physical specifications</b>	(H x W x D): 1.58 X 3.25 X 13.7 in Weight: 3 lb (1.4 kg)	(H x W x D): 1.58 X 3.25 X 12.20 in Weight: 2.8 lb (1.3 kg)	(H x W x D): 1.58 X 3.25 X 12.20 in Weight: 2.6 lb (1.2 kg)	(H x W x D): 1.58 X 3.25 X 12.20 in Weight: 2.6 lb (1.2 kg)
<b>Operating temperature</b>	23 to 113°F (-5 to 45°C)			
<b>Storage temperature</b>	-40 to 158°F (-40 to 70°C)			
<b>Relative humidity operating and nonoperating noncondensing</b>	5 to 90% noncondensing			
<b>Altitude</b>	10,000 ft. (3000 meters), up to 45°C			
<b>MTBF</b>	Calculated MTBF must be greater than 300,000 using Telcordia SR-332, Method 1, Case 3. Demonstrated MTBF is 500,000 hr (with 90% confidence level).			
<b>EMI and EMC compliance</b>	FCC Part 15 (CFR 47) Class A ICES-003 Class A EN 55022 Class A CISPR 22 Class A AS/NZS 3548 Class A BSMI Class A (AC input models only) VCCI Class A EN 55024, EN300386, EN 50082-1, EN 61000-3-2, EN 61000-3-3 EN61000-4-2, EN61000-4-3, EN61000-4-4, EN61000-4-5, EN61000-4-6, EN 61000-6-1			
<b>Safety compliance</b>	UL 60950-1, CAN/CSA-C22.2 No. 60950-1, EN 60950-1, IEC 60950-1, CCC, CE Marking			
<b>LED indicators</b>	"AC OK": Input power to the power supply is OK "PS OK": Output power from the power supply is OK			

## Power Consumption of Standalone Cisco Catalyst 3850 Series Switches

Table 14 shows power consumption of standalone Cisco Catalyst 3850 Series Switches based on Alliance for Telecommunications Industry Solutions (ATIS) testing using IMIX distribution stream traffic, with input voltage of 115VAC at 60 Hz and no PoE loading. The values given are the maximum possible power consumption numbers under the respective test scenarios.

**Table 14.** Power Consumptions (in Watts) of Standalone Cisco Catalyst 3850 Series

Models	Uplink Module	Power Consumption (W) (No More Than)			
		0% Traffic	10% Traffic	100% Traffic	Weighted Average
WS-C3850-12S	C3850-NM-4-1G	85.84	85.89	86.75	86.0
WS-C3850-24S		104.48	104.25	105.12	104.4
WS-C3850-12S	C3850-NM-2-10G	87.95	88.30	90.04	88.4
WS-C3850-24S		106.24	106.58	109.75	106.9
WS-C3850-24T	C3850-NM-4-1G	83.47	82.86	83.76	83.04
WS-C3850-24P		86.81	86.22	87.11	86.40
WS-C3850-24U		81.5	81.4	82.1	81.5
WS-C3850-48T		117.74	116.62	117.59	116.89
WS-C3850-48P		125.35	124.15	125.15	124.43
WS-C3850-48F		130.10	128.91	129.85	129.18
WS-C3850-48U		114.8	114.7	115.6	114.8
WS-C3850-24T	C3850-NM-2-10G	81.97	81.83	84.97	82.16
WS-C3850-24P		85.22	85.04	88.32	85.39
WS-C3850-24U		82.8	82.6	84.8	82.9

Models	Uplink Module	Power Consumption (W) (No More Than)			
		0% Traffic	10% Traffic	100% Traffic	Weighted Average
WS-C3850-48T	C3850-NM-4-10G	117.56	116.74	120.40	117.23
WS-C3850-48P		123.78	122.90	126.75	123.42
WS-C3850-48F		129.89	129.06	132.36	129.18
WS-C3850-48U		116.8	116.9	119.9	117.2
WS-C3850-48T		120.56	120.28	127.24	121.02
WS-C3850-48P		129.59	129.64	135.96	130.27
WS-C3850-48F		137.57	137.06	143.77	137.81
WS-C3850-48U		119.9	121.2	127.7	121.5
WS-C3850-12XS	C3850-NM-8-10G	109.0	109.5	112.7	109.7
WS-C3850-24XU		229.7	231.2	248.1	232.7
WS-C3850-12X48U		191.3	193.6	208.1	194.8
WS-C3850-24XS	C3850-NM-2-40G	183.6	185.3	205.5	187.2
WS-C3850-24XS		159.2	161.1	177.0	162.5
WS-C3850-48XS	None	267.0	268.3	288.1	270.1

## Safety and Compliance

Table 15 lists the safety and compliance information for the Cisco Catalyst 3850 Series.

**Table 15.** Safety and Compliance Information for Cisco Catalyst 3850 Series

Description	Specification
<b>Safety certifications</b>	UL 60950-1 Second Edition CAN/CSA-C22.2 No. 60950-1 Second Edition EN 60950-1 Second Edition IEC 60950-1 Second Edition NOM (obtained by partners and distributors)
<b>Electromagnetic emissions certifications</b>	47CFR Part 15 (CFR 47) Class A (FCC Part 15 Class A) AS/NZS CISPR22 Class A CISPR22 Class A EN55022 Class A ICES003 Class A VCCI Class A EN61000-3-2 EN61000-3-3 KN22 Class A KCC CNS13438 Class A EN55024 CISPR24 KN24
<b>Environmental</b>	Reduction of Hazardous Substances (ROHS) 5
<b>Noise specifications</b>	Office Product Spec: 48dBA at 30°C (refer to ISO 7779)
<b>Telco</b>	CLEI code

## Cisco Enhanced Limited Lifetime Hardware Warranty

The Cisco Catalyst 3850 Series Switches come with an E-LLW that includes NBD delivery of replacement hardware where available and 90 days of 8x5 Cisco TAC support.

Your formal warranty statement, including the warranty applicable to Cisco software, appears in the Cisco information packet that accompanies your Cisco product. We encourage you to review carefully the warranty statement shipped with your specific product before use.

Cisco reserves the right to refund the purchase price as its exclusive warranty remedy.

For further information about warranty terms, visit <http://www.cisco.com/go/warranty>. Table 16 provides information about the E-LLW.

**Table 16.** E-LLW Details

	Cisco E-LLW
<b>Device covered</b>	Applies to Cisco Catalyst 3850 Series Switches.
<b>Warranty duration</b>	As long as the original customer owns the product.
<b>EoL policy</b>	In the event of discontinuance of product manufacture, Cisco warranty support is limited to 5 years from the announcement of discontinuance.
<b>Hardware replacement</b>	Cisco or its service center will use commercially reasonable efforts to ship a replacement for NBD delivery, where available. Otherwise, a replacement will be shipped within 10 working days after receipt of the RMA request. Actual delivery times might vary depending on customer location.
<b>Effective date</b>	Hardware warranty commences from the date of shipment to customer (and in case of resale by a Cisco reseller, not more than 90 days after original shipment by Cisco).
<b>TAC support</b>	Cisco will provide during business hours, 8 hours per day, 5 days per week basic configuration, diagnosis, and troubleshooting of device-level problems for up to a 90-day period from the date of shipment of the originally purchased Cisco Catalyst 3850 product. This support does not include solution or network-level support beyond the specific device under consideration.
<b>Cisco.com access</b>	Warranty allows guest access only to Cisco.com.

## Licensing for Cisco Catalyst 3850 Series Switches

The three feature sets available with all Cisco Catalyst 3850 Series Switches are:

- LAN Base: Enterprise access layer 2 switching features
- IP Base: Enterprise access layer 3 switching features
- IP Services: Advanced enterprise layer 3 switching (IPv4 and IPv6) features

The LAN Base feature set offers enhanced intelligent services that include comprehensive Layer 2 features, with up to 255 VLANs. The IP Base feature set provides entry-level enterprise services in addition to all LAN Base features, with 1K VLANs. IP Base also includes the support for wireless controller functionality (mobility agent and mobility controller role; additional access point license required for mobility controller role), routed access, smart operations, FNF, and so on. The IP Services feature set provides full enterprise services that include advanced Layer 3 features such as EIGRP, OSPF, BGP, PIM, and IPv6 routing such as OSPFv3 and EIGRPv6. All software feature sets support advanced security and MQC-based QoS.

The Cisco Catalyst 3850 Series Switches with LAN Base feature set can only stack with other Cisco Catalyst 3850 Series LAN Base switches. The same applies to IP Base and IP Services as well. A mixed stack of LAN Base switch with IP Base or IP Services feature set is not supported.

---

The 12-port and 24-port SFP+- and SFP-based models as well as the 48-port SFP+ model can only be ordered with IP Base or IP Services licenses. Therefore, in order to stack with LAN Base models, they need to be configured in LAN Base mode from the CLI.

Customers can transparently upgrade the software feature set in the Cisco Catalyst 3850 Series Switches through Cisco IOS Software CLI using the right to use (RTU)-based software upgrade process. Software activation enables the Cisco IOS Software feature sets. Based on the license's type, Cisco IOS Software activates the appropriate feature set. License types can be changed, or upgraded, to activate a different feature set.

### **Access Point License for Cisco Catalyst 3850**

An access point license is required for Cisco Catalyst 3850 operating in mobility controller mode. No access point license is required for 3850 operating in mobility agent mode. This functionality is included in the IP Base feature set. Other devices that can act as mobility controller are the WLC 5760, WLC 5508, and WiSM2 wireless controllers. Access point licenses can be transferred only between two 3850 switches or between 3850 and 5760 controller and vice versa.

### **Software Policy for Cisco Catalyst 3850 Series Switches**

Customers with Cisco Catalyst LAN Base and IP Base software feature sets will be provided with maintenance updates and bug fixes designed to maintain the compliance of the software with published specifications, release notes, and industry standards compliance as long as the original end user continues to own or use the product or up to one year from the end-of-sale date for this product, whichever occurs earlier. Customers with licenses for our IP Services software images require a service support contract such as Cisco SMARTnet™ Service to download updates. This policy supersedes any previous warranty or software statement and is subject to change without notice.

### **Cisco ONE Software**

[Cisco ONE Software for Access Switching](#) is available for the Cisco Catalyst 3850 Series Switches.

Cisco ONE Software is a new way for customers to purchase and use our infrastructure software. It offers a simplified consumption model, centered on common customer scenarios in the data center, WANs, and LANs.

Cisco ONE Software and services provide customers with four primary benefits:

- Software suites that address typical customer use scenarios at an attractive price
- Investment protection of their software purchase through software services-enabled license portability
- Access to ongoing innovation and new technology with Cisco Software Support Service (SWSS)
- Flexible licensing models to smoothly distribute customer's software spend over time

For ordering information for Cisco ONE Software for the Cisco Catalyst 3850 Series Switches, go to <http://www.cisco.com/c/en/us/products/software/one-access/switching-part-numbers.html>.

### **Cisco and Partner Services for Next-Generation Cisco Catalyst Fixed Switches**

Enable the innovative, secure, intelligent edge in the Borderless Network Architecture using personalized services from Cisco and our partners. Through a discovery process that begins with understanding your business objectives, we help you integrate the next-generation Cisco Catalyst fixed switches into your architecture and incorporate network services onto that platform. Sharing knowledge and leading practices, we support your success every step of the way as you deploy, absorb, manage, and scale new technology.

Choose from a flexible suite of support services designed to meet your business needs and help you maintain high-quality network performance while controlling operational costs. (See Table 17.)

**Table 17.** Technical Services Available for Cisco Catalyst 3850 Switches

Technical Services
<p><b>Cisco SMARTnet Service</b></p> <ul style="list-style-type: none"> <li>• Around-the-clock, global access to the Cisco TAC</li> <li>• Unrestricted access to the extensive Cisco.com knowledge base and tools</li> <li>• Next-business-day, 8x5x4, 24x7x4, and 24x7x2 advance hardware replacement and onsite parts replacement and installation available</li> <li>• Ongoing operating system software updates within the licensed feature set</li> <li>• Proactive diagnostics and real-time alerts on Smart Call Home-enabled devices</li> </ul>
<p><b>Cisco Smart Foundation Service</b></p> <ul style="list-style-type: none"> <li>• NBD advance hardware replacement as available</li> <li>• Business hours access to SMB TAC (access levels vary by region)</li> <li>• Access to Cisco.com SMB knowledge base</li> <li>• Online technical resources through Smart Foundation Portal</li> <li>• Operating system software bug fixes and patches</li> </ul>
<p><b>Cisco SP Base Service</b></p> <ul style="list-style-type: none"> <li>• Around-the-clock, global access to the Cisco TAC</li> <li>• Registered access to Cisco.com</li> <li>• NBD, 8x5x4, 24x7x4, and 24x7x2 advance hardware replacement; return to factory option available<sup>2</sup></li> <li>• Ongoing operating system software updates<sup>1</sup></li> </ul>
<p><b>Cisco Focused Technical Support Services</b></p> <ul style="list-style-type: none"> <li>• Three levels of premium, high-touch services are available: <ul style="list-style-type: none"> <li>◦ Cisco High-Touch Operations Management Service</li> <li>◦ Cisco High-Touch Technical Support Service</li> <li>◦ Cisco High-Touch Engineering Service</li> </ul> </li> <li>• Valid Cisco SMARTnet or SP Base contracts on all network equipment are required</li> </ul>

**Notes:**

<sup>1</sup> Cisco operating system updates include the following: maintenance releases, minor updates, and major updates within the licensed feature set.

<sup>2</sup> Advance hardware replacement is available in various service-level combinations. For example, 8x5xNBD indicates that shipment will be initiated during the standard 8-hour business day, 5 days a week (the generally accepted business days within the relevant region), with NBD delivery. Where NBD is not available, same day ship is provided. Restrictions apply; for details, review the appropriate service descriptions.

**Ordering Information**

Table 18 lists ordering information for the Cisco Catalyst 3850 Series. To place an order, visit the Cisco Ordering homepage at [http://www.cisco.com/en/US/ordering/or13/or8/order\\_customer\\_help\\_how\\_to\\_order\\_listing.html](http://www.cisco.com/en/US/ordering/or13/or8/order_customer_help_how_to_order_listing.html).

**Table 18.** Cisco Catalyst 3850 Series Ordering Information

Product Number	Product Description
<b>Cisco Catalyst 3850 Series</b>	
<b>WS-C3850-24T-L</b>	Stackable 24 10/100/1000 Ethernet ports, with 350WAC power supply 1 RU, LAN Base feature set (StackPower cables need to be purchased separately)
<b>WS-C3850-48T-L</b>	Stackable 48 10/100/1000 Ethernet ports, with 350WAC power supply 1 RU, LAN Base feature set (StackPower cables need to be purchased separately)
<b>WS-C3850-24P-L</b>	Stackable 24 10/100/1000 Ethernet PoE+ ports, with 715WAC power supply 1 RU, LAN Base feature set (StackPower cables need to be purchased separately)
<b>WS-C3850-24U-L</b>	Stackable 24 10/100/1000 Ethernet UPOE ports, with 1100WAC power supply 1 RU, LAN Base feature set (StackPower cables need to be purchased separately)

Product Number	Product Description
<b>WS-C3850-48P-L</b>	Stackable 48 10/100/1000 Ethernet PoE+ ports, with 715WAC power supply 1 RU, LAN Base feature set (StackPower cables need to be purchased separately)
<b>WS-C3850-48F-L</b>	Stackable 48 10/100/1000 Ethernet PoE+ ports, with 1100WAC power supply 1 RU, LAN Base feature set (StackPower cables need to be purchased separately)
<b>WS-C3850-48U-L</b>	Stackable 48 10/100/1000 Ethernet UPOE ports, with 1100WAC power supply 1 RU, LAN Base feature set (StackPower cables need to be purchased separately)
<b>WS-C3850-24T-S</b>	Stackable 24 10/100/1000 Ethernet ports, with 350WAC power supply 1 RU, IP Base feature set
<b>WS-C3850-48T-S</b>	Stackable 48 10/100/1000 Ethernet ports, with 350WAC power supply 1 RU, IP Base feature set
<b>WS-C3850-24P-S</b>	Stackable 24 10/100/1000 Ethernet PoE+ ports, with 715WAC power supply 1 RU, IP Base feature set
<b>WS-C3850-24U-S</b>	Stackable 24 10/100/1000 Ethernet UPOE ports, with 1100WAC power supply 1 RU, IP Base feature set
<b>WS-C3850-48P-S</b>	Stackable 48 10/100/1000 Ethernet PoE+ ports, with 715WAC power supply 1 RU, IP Base feature set
<b>WS-C3850-48F-S</b>	Stackable 48 10/100/1000 Ethernet PoE+ ports, with 1100WAC power supply 1 RU, IP Base feature set
<b>WS-C3850-48U-S</b>	Stackable 48 10/100/1000 Ethernet UPOE ports, with 1100WAC power supply 1 RU, IP Base feature set
<b>WS-C3850-24T-E</b>	Stackable 24 10/100/1000 Ethernet ports, with 350WAC power supply 1 RU, IP Services feature set
<b>WS-C3850-48T-E</b>	Stackable 48 10/100/1000 Ethernet ports, with 350WAC power supply 1 RU, IP Services feature set
<b>WS-C3850-24P-E</b>	Stackable 24 10/100/1000 Ethernet PoE+ ports, with 715WAC power supply 1 RU, IP Services feature set
<b>WS-C3850-24U-E</b>	Stackable 24 10/100/1000 Ethernet UPOE ports, with 1100WAC power supply 1 RU, IP Services feature set
<b>WS-C3850-48P-E</b>	Stackable 48 10/100/1000 Ethernet PoE+ ports, with 715WAC power supply 1 RU, IP Services feature set
<b>WS-C3850-48F-E</b>	Stackable 48 10/100/1000 Ethernet PoE+ ports, with 1100WAC power supply 1 RU, IP Services feature set
<b>WS-C3850-48U-E</b>	Stackable 48 10/100/1000 Ethernet UPOE ports, with 1100WAC power supply 1 RU, IP Services feature set
<b>WS-C3850-12X48U-L</b>	Stackable 48 10/100/1000 with 12 100Mbps/1/2.5/5/10 Gbps UPOE Ethernet ports, with 1100W AC power supply 1RU, LAN Base feature set
<b>WS-C3850-12X48U-S</b>	Stackable 48 10/100/1000 with 12 100Mbps/1/2.5/5/10 Gbps UPOE Ethernet ports, with 1100W AC power supply 1RU, IP Base feature set
<b>WS-C3850-12X48U-E</b>	Stackable 48 10/100/1000 with 12 100Mbps/1/2.5/5/10 Gbps UPOE Ethernet ports, with 1100W AC power supply 1RU, IP Services feature set
<b>WS-C3850-24XU-L</b>	Stackable 24 100Mbps/1/2.5/5/10 Gbps UPOE Ethernet ports, with 1100W AC power supply 1RU, LAN Base feature set
<b>WS-C3850-24XU-S</b>	Stackable 24 100Mbps/1/2.5/5/10 Gbps UPOE Ethernet ports, with 1100W AC power supply 1RU, IP Base feature set
<b>WS-C3850-24XU-E</b>	Stackable 24 100Mbps/1/2.5/5/10 Gbps UPOE Ethernet ports, with 1100W AC power supply 1RU, IP Services feature set
<b>WS-C3850-12S-S</b>	Stackable 12 SFP Ethernet ports, with 350WAC power supply 1 RU, IP Base feature set

Product Number	Product Description
<b>WS-C3850-12S-E</b>	Stackable 12 SFP Ethernet ports, with 350WAC power supply 1 RU, IP Services feature set
<b>WS-C3850-24S-S</b>	Stackable 24 SFP Ethernet ports, with 350WAC power supply 1 RU, IP Base feature set
<b>WS-C3850-24S-E</b>	Stackable 24 SFP Ethernet ports, with 350WAC power supply 1 RU, IP Services feature set
<b>WS-C3850-12XS-S</b>	Stackable 12 SFP+ Ethernet ports, with 350WAC power supply 1 RU, IP Base feature set
<b>WS-C3850-12XS-E</b>	Stackable 12 SFP+ Ethernet ports, with 350WAC power supply 1 RU, IP Services feature set
<b>WS-C3850-24XS-S</b>	Stackable 24 SFP+ Ethernet ports, with 715WAC power supply 1 RU, IP Base feature set
<b>WS-C3850-24XS-E</b>	Stackable 24 SFP+ Ethernet ports, with 715WAC power supply 1 RU, IP Services feature set
<b>WS-C3850-48XS-S</b>	Standalone, 48 SFP+ and 4 QSFP+ Ethernet ports, with 750WAC front-to-back power supply 1 RU, IP Base feature set
<b>WS-C3850-48XS-E</b>	Standalone, 48 SFP+ and 4 QSFP+ Ethernet ports, with 750WAC front-to-back power supply 1 RU, IP Services feature set
<b>WS-C3850-48XS-F-S</b>	Standalone, 48 SFP+ and 4 QSFP+ Ethernet ports, with 750WAC back-to-front power supply 1 RU, IP Base feature set
<b>WS-C3850-48XS-F-E</b>	Standalone, 48 SFP+ and 4 QSFP+ Ethernet ports, with 750WAC back-to-front power supply 1 RU, IP Services feature set
<b>Cisco Catalyst 3850 Bundles</b>	
<b>WS-C3850-24PW-S</b>	Cisco Catalyst 3850 24-port PoE IP Base with 5 access point license
<b>WS-C3850-48PW-S</b>	Cisco Catalyst 3850 48-port PoE IP Base with 5 access point license
<b>WS-C3850-24UW-S</b>	Cisco Catalyst 3850 24 Port UPOE with 5 access point licenses IP Base
<b>WS-C3850-48W-S</b>	Cisco Catalyst 3850 48 Port PoE with 5 access point licenses IP Base
<b>WS-C3850-48UW-S</b>	Cisco Catalyst 3850 48 Port UPOE with 5 access point licenses IP Base
<b>WS-C3850-24XUW-S</b>	Cisco Catalyst 3850 24 Port UPOE with 24 100Mbps/1/2.5/5/10 Gbps and 5 access point licenses IP Base
<b>WS-C3850-12X48UW-S</b>	Cisco Catalyst 3850 48 Port UPOE with 12 100Mbps/1/2.5/5/10 Gbps and 5 access point licenses IP Base
<b>WS-C3850-16XS-S</b>	Cisco Catalyst 3850 12 SFP+ port stackable model, with C3850-NM-4-10G module and 350WAC power supply. 1 RU, IP Base feature set
<b>WS-C3850-16XS-E</b>	Cisco Catalyst 3850 12 SFP+ port stackable model, with C3850-NM-4-10G module and 350WAC power supply. 1 RU, IP Services feature set
<b>WS-C3850-32XS-S</b>	Cisco Catalyst 3850 24 SFP+ port stackable model, with C3850-NM-8-10G module and 715WAC power supply. 1 RU, IP Base feature set
<b>WS-C3850-32XS-E</b>	Cisco Catalyst 3850 24 SFP+ port stackable model, with C3850-NM-8-10G module and 715WAC power supply. 1 RU, IP Services feature set
<b>Network Modules for the Cisco Catalyst 3850 Series</b>	
<b>C3850-NM-4-1G=</b>	4 x Gigabit Ethernet network module spare
<b>C3850-NM-2-10G=</b>	4 x Gigabit Ethernet/2 x 10 Gigabit Ethernet network module spare
<b>C3850-NM-BLANK=</b>	Network module blank spare
<b>C3850-NM-4-10G=</b>	4 x Gigabit Ethernet/4 x 10 Gigabit Ethernet network module spare
<b>C3850-NM-8-10G=</b>	8 x Gigabit Ethernet/8 x 10 Gigabit Ethernet network module spare
<b>C3850-NM-2-40G=</b>	2 x 40 Gigabit Ethernet network module spare
<b>Software Licenses</b>	
<b>C3850-12-S-E</b>	Cisco Catalyst 3850 12-port IP Base to IP Services RTU paper license
<b>C3850-24-L-S</b>	Cisco Catalyst 3850 24-port Switch LAN Base to IP Base RTU paper license

Product Number	Product Description
<b>C3850-48-L-S</b>	Cisco Catalyst 3850 48-port Switch LAN Base to IP Base RTU paper license
<b>C3850-24-L-E</b>	Cisco Catalyst 3850 24-port LAN Base to IP Services RTU paper license
<b>C3850-48-L-E</b>	Cisco Catalyst 3850 48-port LAN Base to IP Services RTU paper license
<b>C3850-24-S-E</b>	Cisco Catalyst 3850 24-port IP Base to IP Services RTU paper license
<b>C3850-48-S-E</b>	Cisco Catalyst 3850 48-port IP Base to IP Services RTU paper license
<b>L-C3850-24-L-S</b>	Cisco Catalyst 3850 24-port LAN Base to IP Base RTU electronic license
<b>L-C3850-48-L-S</b>	Cisco Catalyst 3850 48-port LAN Base to IP Base RTU electronic license
<b>L-C3850-24-L-E</b>	Cisco Catalyst 3850 24-port LAN Base to IP Services RTU electronic license
<b>L-C3850-48-L-E</b>	Cisco Catalyst 3850 48-port LAN Base to IP Services RTU electronic license
<b>L-C3850-24-S-E</b>	Cisco Catalyst 3850 24-port IP Base to IP Services RTU electronic license
<b>L-C3850-48-S-E</b>	Cisco Catalyst 3850 48-port IP Base to IP Services RTU electronic license
<b>L-C3850-12-S-E</b>	Cisco Catalyst 3850 12-port IP Base to IP Services RTU electronic license
<b>Access Point Licenses</b>	
<b>L-LIC-CT3850-UPG</b>	Primary upgrade license SKU for Cisco 3850 wireless controller (e-delivery)
<b>L-LIC-CTIOS-1A</b>	1 access point adder license for Cisco IOS Software based wireless controller (e-delivery)
<b>LIC-CT3850-UPG</b>	Primary upgrade license SKU for Cisco 3850 wireless controller (paper license)
<b>LIC-CTIOS-1A</b>	1 access point adder license for the Cisco IOS Software based wireless controller (paper license)
<b>Power Supplies and Fan for the Cisco Catalyst 3850 Series</b>	
<b>PWR-C1-350WAC=</b>	350WAC power supply spare
<b>PWR-C1-715WAC=</b>	715WAC power supply spare
<b>PWR-C1-1100WAC=</b>	1100WAC power supply spare
<b>PWR-C1-440WDC=</b>	440WDC power supply spare
<b>PWR-C1-BLANK=</b>	Power supply blank spare
<b>PWR-C3-750WAC-R=</b>	750WAC power supply spare front-to-back airflow for 48XS
<b>PWR-C3-750WAC-F=</b>	750WAC power supply spare back-to-front airflow for 48XS
<b>PWR-C3-750WDC-R=</b>	750WDC power supply spare front-to-back airflow for 48XS
<b>PWR-C3-750WDC-F=</b>	750WDC power supply spare back-to-front airflow for 48XS
<b>FAN-T3-R=</b>	Fan module spare front-to-back airflow for 48XS
<b>FAN-T3-F=</b>	Fan module spare back-to-front airflow for 48XS
<b>C3850-FAN-T1=</b>	Cisco Catalyst 3850 and WLC 5760 Type 1 Fan Module
<b>StackWise-480 and StackPower Cables for the Cisco Catalyst 3850 Series</b>	
<b>STACK-T1-50CM=</b>	Cisco StackWise-480 50cm stacking cable spare
<b>STACK-T1-1M=</b>	Cisco StackWise-480 1m stacking cable spare
<b>STACK-T1-3M=</b>	Cisco StackWise-480 3m stacking cable spare
<b>CAB-SPWR-30CM=</b>	Cisco Catalyst 3850 StackPower cable 30cm spare
<b>CAB-SPWR-150CM=</b>	Cisco Catalyst 3850 StackPower cable 150cm spare
<b>Spare Power Cords for the Cisco Catalyst 3850 Series</b>	
<b>CAB-TA-NA=</b>	AC power cord for Cisco Catalyst 3850 (North America)
<b>CAB-TA-AP=</b>	AC power cord for Cisco Catalyst 3850 (Australia)
<b>CAB-TA-AR=</b>	AC power cord for Cisco Catalyst 3850 (Argentina)
<b>CAB-TA-SW=</b>	AC power cord for Cisco Catalyst 3850 (Switzerland)
<b>CAB-TA-UK=</b>	AC power cord for Cisco Catalyst 3850 (United Kingdom)
<b>CAB-TA-JP=</b>	AC power cord for Cisco Catalyst 3850 (Japan)
<b>CAB-TA-250VAC-JP=</b>	Japan 250VAC power cord for Cisco Catalyst 3850 (Japan)



Product Number	Product Description
<b>CAB-TA-EU=</b>	AC power cord for Cisco Catalyst 3850 (Europe)
<b>CAB-TA-IT=</b>	AC power cord for Cisco Catalyst 3850 (Italy)
<b>CAB-TA-IN=</b>	AC power cord for Cisco Catalyst 3850 (India)
<b>CAB-TA-CN=</b>	AC power cord for Cisco Catalyst 3850 (China)
<b>CAB-TA-DN=</b>	AC power cord for Cisco Catalyst 3850 (Denmark)
<b>CAB-TA-IS=</b>	AC power cord for Cisco Catalyst 3850 (Israel)
<b>CAB-ACBZ-12A=</b>	AC power cord for Cisco Catalyst 3850 (Brazil), 12A/125V BR-3-20 plug up to 12A
<b>CAB-ACBZ-10A=</b>	AC power cord for Cisco Catalyst 3850 (Brazil), 10A/250V BR-3-10 plug up to 10A
<b>CAB-C15-CBN</b>	Cabinet jumper power cord, 250 VAC 13A, C14-C15 connectors
<b>Spare Accessory and Rack Mount Kits for the Cisco Catalyst 3850 Series</b>	
<b>C3850-ACC-KIT=</b>	Accessory kit for Cisco Catalyst 3850 Series
<b>C3850-RAC-KIT=</b>	Rack mount kit for Cisco Catalyst 3850 Series
<b>C3850-4PT-KIT=</b>	Extension rails and brackets for four-point mounting for Cisco Catalyst 3850 Series

## Optics Compatibility Information

The Cisco Catalyst 3850 Series supports a wide range of optics. Because the list of supported optics is updated on a regular basis, consult the tables available here for the latest QSFP+, SFP+, and SFP compatibility information:

[http://www.cisco.com/en/US/products/hw/modules/ps5455/products\\_device\\_support\\_tables\\_list.html](http://www.cisco.com/en/US/products/hw/modules/ps5455/products_device_support_tables_list.html).

## Cisco Capital

### Financing to Help You Achieve Your Objectives

Cisco Capital can help you acquire the technology you need to achieve your objectives and stay competitive. We can help you reduce CapEx. Accelerate your growth. Optimize your investment dollars and ROI. Cisco Capital financing gives you flexibility in acquiring hardware, software, services, and complementary third-party equipment. And there's just one predictable payment. Cisco Capital is available in more than 100 countries. [Learn more.](#)



Americas Headquarters  
Cisco Systems, Inc.  
San Jose, CA

Asia Pacific Headquarters  
Cisco Systems (USA) Pte. Ltd.  
Singapore

Europe Headquarters  
Cisco Systems International BV Amsterdam,  
The Netherlands

Cisco has more than 200 offices worldwide. Addresses, phone numbers, and fax numbers are listed on the Cisco Website at [www.cisco.com/go/offices](http://www.cisco.com/go/offices).

Cisco and the Cisco logo are trademarks or registered trademarks of Cisco and/or its affiliates in the U.S. and other countries. To view a list of Cisco trademarks, go to this URL: [www.cisco.com/go/trademarks](http://www.cisco.com/go/trademarks). Third party trademarks mentioned are the property of their respective owners. The use of the word partner does not imply a partnership relationship between Cisco and any other company. (1110R)

# **DATASHEET SWITCH CISCO 3560**

## Cisco Catalyst 3560 Series Switches

### Product Overview

The Cisco® Catalyst® 3560 Series is a line of fixed-configuration, enterprise-class switches that include IEEE 802.3af and Cisco prestandard Power over Ethernet (PoE) functionality in Fast Ethernet and Gigabit Ethernet configurations. The Cisco Catalyst 3560 is an ideal access layer switch for small enterprise LAN access or branch-office environments, combining both 10/100/1000 and PoE configurations for maximum productivity and investment protection while enabling the deployment of new applications such as IP telephony, wireless access, video surveillance, building management systems, and remote video kiosks. Customers can deploy networkwide intelligent services—such as advanced quality of service (QoS), rate limiting, access control lists (ACLs), multicast management, and high-performance IP routing—while maintaining the simplicity of traditional LAN switching. Available for the Cisco Catalyst 3560 Series at no charge, the Cisco Network Assistant is a centralized management application that simplifies the administration tasks for Cisco switches, routers, and wireless access points. Cisco Network Assistant provides configuration wizards that greatly simplify the implementation of converged networks and intelligent network services.

The Cisco Catalyst 3560 is part of a larger and more scalable family of Cisco Catalyst switches that includes the Cisco Catalyst 3560-E Series switches, the Cisco Catalyst 3750 and 3750-E Series switches with Cisco StackWise™ technology, and the Cisco Catalyst 4500 and Catalyst 6500 modular switches. United by Cisco IOS® Software, the entire family offers industry-leading availability, integrated security, optimized delivery, and manageability.

### Configurations

The Cisco Catalyst 3560 Series comprises the following switches (refer to Figure 1):

**Figure 1.** Cisco Catalyst 3560 Switches



- Cisco Catalyst 3560-8PC: 8 Ethernet 10/100 ports with PoE and 1 dual-purpose 10/100/1000 and SFP port; compact form factor with no fan
- Cisco Catalyst 3560-12PC: 12 Ethernet 10/100 ports with PoE and 1 dual-purpose 10/100/1000 and SFP port; compact form factor with no fan
- Cisco Catalyst 3560-24TS: 24 Ethernet 10/100 ports and 2 Small Form-Factor Pluggable (SFP)-based Gigabit Ethernet ports; 1 rack unit (RU)

- Cisco Catalyst 3560-48TS: 48 Ethernet 10/100 ports and 4 SFP-based Gigabit Ethernet ports; 1RU
- Cisco Catalyst 3560-24PS: 24 Ethernet 10/100 ports with PoE and 2 SFP-based Gigabit Ethernet ports; 1 RU
- Cisco Catalyst 3560-48PS: 48 Ethernet 10/100 ports with PoE and 4 SFP-based Gigabit Ethernet ports; 1RU
- Cisco Catalyst 3560G-24TS: 24 Ethernet 10/100/1000 ports and 4 SFP-based Gigabit Ethernet ports; 1RU
- Cisco Catalyst 3560G-48TS: 48 Ethernet 10/100/1000 ports and 4 SFP-based Gigabit Ethernet ports; 1RU
- Cisco Catalyst 3560G-24PS: 24 Ethernet 10/100/1000 ports with PoE and 4 SFP-based Gigabit Ethernet ports; 1RU
- Cisco Catalyst 3560G-48PS: 48 Ethernet 10/100/1000 ports with PoE and 4 SFP-based Gigabit Ethernet ports; 1RU

The Cisco Catalyst 3560 Series can be purchased with the IP Base or IP Services licenses pre-installed. The IP Base license offers advanced QoS, rate limiting, ACLs, and basic static and Routing Information Protocol (RIP) routing functions. The IP Services license provides a richer set of enterprise-class features, including advanced hardware-based IPv6 unicast and IPv6 Multicast routing as well as policy-based routing (PBR). The IP Services license upgrades Cisco Catalyst 3560 Series switches to include IPv6 routing support. Upgrade licenses are available to upgrade a switch from the IP Base license to the IP Services license.

The SFP-based GE ports accommodate a range of SFP transceivers, including the Cisco 1000BASE-T, 1000BASE-SX, 1000BASE-LX, 1000BASE-ZX, and CWDM SFP transceivers. These ports also support the Cisco Catalyst 3560 SFP Interconnect Cable for establishing a low-cost Gigabit Ethernet point-to-point connection.

### **Power over Ethernet**

The Cisco Catalyst 3560 Series can provide a lower total cost of ownership (TCO) for deployments that incorporate Cisco IP phones, Cisco Aironet® wireless LAN (WLAN) access points, or any IEEE 802.3af-compliant end device. PoE removes the need for wall power to each PoE-enabled device and eliminates the cost for additional electrical cabling that would otherwise be necessary in IP phone and WLAN deployments. The Cisco Catalyst 3560 8-port PoE and 24-port PoE configurations can support 8 and 24 simultaneous full-powered PoE ports at 15.4W for maximum powered-device support. The Cisco Catalyst 3560 12-port PoE can support 8 ports at 15.4W or 12 ports at 10W or any combination in between. Taking advantage of Cisco Catalyst Intelligent Power Management, the 48-port PoE configurations can deliver the necessary power to support 24 ports at 15.4W, 48 ports at 7.7W, or any combination in between. Maximum power availability for a converged voice and data network is attainable when a Cisco Catalyst 3560 switch is combined with the Cisco RPS 2300 Redundant Power System for transparent protection against internal power supply failures and an uninterruptible power supply (UPS) system to safeguard against power outages.

### **Gigabit Ethernet**

At speeds of 1000 Mbps, Gigabit Ethernet provides the bandwidth to meet new and evolving network demands, alleviate bottlenecks, and boost performance while increasing the return on existing infrastructure investments. Today's workers are placing higher demands on networks,

running multiple, concurrent applications. For example, a worker joins a team conference call through an IP videoconference, sends a 10-MB spreadsheet to meeting participants, broadcasts the latest marketing video for the team to evaluate, and queries the customer-relationship-management database for the latest real-time feedback. Meanwhile, a multigigabyte system backup starts in the background and the latest virus updates are delivered to the client. The Cisco Catalyst 3560 provides a means to intelligently scale the network beyond 100 Mbps over existing Category 5 copper cabling and simultaneously support PoE for maximum productivity and investment protection.

### **Intelligence in the Network**

Networks of today are evolving to address four new developments at the network edge:

- Increase in desktop computing power
- Introduction of bandwidth-intensive applications
- Expansion of highly sensitive data on the network
- Presence of multiple device types, such as IP phones, WLAN access points, and IP video cameras

These new demands are contending for resources with many existing mission-critical applications. As a result, IT professionals must view the edge of the network as critical to effectively manage the delivery of information and applications.

As companies increasingly rely on networks as the strategic business infrastructure, it is more important than ever to help ensure their high availability, security, scalability, and control. By adding Cisco intelligent functions for LAN access, customers can now deploy networkwide intelligent services that consistently address these requirements from the desktop to the core and through the WAN.

With Cisco Catalyst Intelligent Ethernet switches, Cisco Systems® helps enable companies to realize the full benefits of adding intelligent services into their networks. Deployment of capabilities that make the network infrastructure highly available to accommodate time-critical needs, scalable to accommodate growth, secure enough to protect confidential information, and capable of differentiating and controlling traffic flows is critical to further optimizing network operations.

### **Cisco EnergyWise Technology**

Cisco EnergyWise is an innovative architecture, added to the Cisco Catalyst 3560 switches, promoting companywide sustainability by reducing energy consumption across an entire corporate infrastructure and affecting more than 50 percent of global greenhouse gas emissions created by worldwide building infrastructure, a much greater effect than the 2 percent generated by the IT industry. Cisco EnergyWise enables companies to measure the power consumption of network infrastructure and network-attached devices and manage power consumption with specific policies, reducing power consumption to realize increased cost savings, potentially affecting any powered device.

EnergyWise encompasses a highly intelligent network based approach to communicate messages that measure and control energy between network devices and endpoints. The network discovers Cisco EnergyWise manageable devices, monitors their power consumption, and takes action based on business rules to reduce power consumption. EnergyWise uses a unique domain-naming system to query and summarize information from large sets of devices, making it simpler than traditional network management capabilities. Cisco EnergyWise's management interfaces allow

facilities and network management applications to communicate with endpoints and each other using the network as a unifying fabric. The management interface uses standard SNMP or SSL to integrate Cisco and third-party management systems.

Cisco EnergyWise extends the network as a platform for power control plane for gathering, managing, and reducing power consumption of all devices, resulting in companywide optimized power delivery and reduced energy costs.

### **Enhanced Security**

With the wide range of security features that the Cisco Catalyst 3560 Series offers, businesses can protect important information, keep unauthorized people off the network, guard privacy, and maintain uninterrupted operation.

Cisco Identity Based Networking Services (IBNS) provides authentication, access control, and security policy administration to secure network connectivity and resources. Cisco IBNS in the Cisco Catalyst 3560 Series prevents unauthorized access and helps ensure that users get only their designated privileges. It provides the ability to dynamically administer granular levels of network access. Using the 802.1x standard and the Cisco Access Control Server (ACS), users can be assigned a VLAN or an ACL upon authentication, regardless of where they connect to the network. This setup allows IT departments to enable strong security policies without compromising user mobility-and with minimal administrative overhead.

To guard against denial-of-service and other attacks, ACLs can be used to restrict access to sensitive portions of the network by denying packets based on source and destination MAC addresses, IP addresses, or TCP/UDP ports. ACL lookups are done in hardware, so forwarding performance is not compromised when implementing ACL-based security.

Port security can be used to limit access on an Ethernet port based on the MAC address of the device to which it is connected. It also can be used to limit the total number of devices plugged into a switch port, thereby protecting the switch from a MAC flooding attack as well as reducing the risks of rogue wireless access points or hubs.

With Dynamic Host Configuration Protocol (DHCP) snooping, DHCP spoofing can be thwarted by allowing only DHCP requests (but not responses) from untrusted user-facing ports. Additionally, the DHCP Interface Tracker (Option 82) helps enable granular control over IP address assignment by augmenting a host IP address request with the switch port ID. Building further on the DHCP snooping capabilities, IP address spoofing can be thwarted using Dynamic ARP Inspection and IP Source Guard.

The MAC Address Notification feature can be used to monitor the network and track users by sending an alert to a management station so that network administrators know when and where users entered the network. The Private VLAN feature isolates ports on a switch, helping ensure that traffic travels directly from the entry point to the aggregation device through a virtual path and cannot be directed to another port.

Secure Shell (SSH) Protocol Version 2, Kerberos, and Simple Network Management Protocol Version 3 (SNMPv3) encrypt administrative and network-management information, protecting the network from tampering or eavesdropping. TACACS+ or RADIUS authentication enables centralized access control of switches and restricts unauthorized users from altering the configurations. Alternatively, a local username and password database can be configured on the switch itself. Fifteen levels of authorization on the switch console and two levels on the Web-based

management interface provide the ability to give different levels of configuration capabilities to different administrators.

### **Availability and Scalability**

The Cisco Catalyst 3560 Series is equipped with a robust set of features that allow for network scalability and higher availability through IP routing as well as a complete suite of Spanning Tree Protocol enhancements aimed to maximize availability in a Layer 2 network.

The Cisco Catalyst 3560 switches deliver high-performance, hardware-based IP routing. The Cisco Express Forwarding-based routing architecture allows for increased scalability and performance. This architecture allows for very high-speed lookups while also helping ensure the stability and scalability necessary to meet the needs of future requirements. In addition to dynamic IP unicast routing, the Cisco Catalyst 3560 Series is perfectly equipped for networks requiring multicast support. Protocol Independent Multicast (PIM) and Internet Group Management Protocol (IGMP) snooping in hardware make the Cisco Catalyst 3560 Series switches ideal for intensive multicast environments.

Implementing routed uplinks to the core improves network availability by enabling faster failover protection and simplifying the Spanning Tree Protocol algorithm by terminating all Spanning Tree Protocol instances at the aggregator switch. If one of the uplinks fails, quicker failover to the redundant uplink can be achieved with a scalable routing protocol such as Open Shortest Path First (OSPF) or Enhanced Interior Gateway Routing Protocol (EIGRP) rather than relying on standard Spanning Tree Protocol convergence. Redirection of a packet after a link failure using a routing protocol results in faster failover than a solution that uses Layer 2 spanning-tree enhancements. Additionally, routed uplinks allow better bandwidth use by implementing equal cost routing (ECR) on the uplinks to perform load balancing. Routed uplinks optimize the utility of uplinks out of the LAN Access by eliminating unnecessary broadcast data flows into the network backbone.

The Cisco Catalyst 3560 also offers dramatic bandwidth savings as a wiring-closet switch in a multicast environment. Using routed uplinks to the network core eliminates the requirement to transmit multiple streams of the same multicast from the upstream content servers to LAN access switches. For example, if three users are assigned to three separate VLANs and they all want to view multicast ABC, then three streams of multicast ABC must be transmitted from the upstream router to the wiring-closet switch—assuming the wiring-closet switch is not capable of routed uplinks. Deploying IP routing to the core with Cisco Catalyst 3560 switches allows users to create a scalable, multicast-rich network. The Cisco IP Services license offers IPv6 routing, including support for simultaneous IPv4 and IPv6 forwarding. IPv6 protocol support includes OSPFv3, and EIGRPv6. IPv6 management and MLD Snooping are supported on all Cisco Catalyst 3560 software images.

Enhancements to the standard Spanning Tree Protocol, such as Per-VLAN Spanning Tree Plus (PVST+), Uplink Fast, and PortFast, maximize network uptime. PVST+ allows for Layer 2 load sharing on redundant links to efficiently use the extra capacity inherent in a redundant design. Uplink Fast, PortFast, and BackboneFast all greatly reduce the standard 30- to 60-second Spanning Tree Protocol convergence time. Loop guard and bridge-protocol-data-unit (BPDU) guard provide Spanning Tree Protocol loop avoidance.



## Advanced QoS

The Cisco Catalyst 3560 offers superior multilayer, granular QoS features to help ensure that network traffic is classified and prioritized, and that congestion is avoided in the best possible manner. Configuration of QoS is greatly simplified through automatic QoS (Auto QoS), a feature that detects Cisco IP phones and automatically configures the switch for the appropriate classification and egress queuing. This optimizes traffic prioritization and network availability without the challenge of a complex configuration.

The Cisco Catalyst 3560 can classify, reclassify, police, mark, queue, and schedule incoming packets, and can queue and schedule packets at egress. Packet classification allows the network elements to discriminate between various traffic flows and enforce policies based on Layer 2 and Layer 3 QoS fields.

To implement QoS, the Cisco Catalyst 3560 Series Switch first identifies traffic flows or packet groups, and classifies or reclassifies these groups using the Differentiated Services Code Point (DSCP) field or the 802.1p Class of Service (CoS) field. Classification and reclassification can be based on criteria as specific as the source or destination IP address, source or destination MAC address, or the Layer 4 TCP or UDP port. At the ingress, the Cisco Catalyst 3560 also polices to determine whether a packet is in or out of profile, marks to change the classification label, passes through or drops out of profile packets, and queues packets based on classification. Control- and data-plane ACLs are supported on all ports to help ensure proper treatment on a per-packet basis.

The Cisco Catalyst 3560 supports four egress queues per port, allowing the network administrator to be more discriminating and specific in assigning priorities for the various applications on the LAN. At egress, the switch performs scheduling and congestion control. Scheduling is an algorithm or process that determines the order in which the queues are processed. The Cisco Catalyst 3560 Series Switch supports shaped round robin (SRR) and strict priority queuing. The SRR algorithm helps ensure differential prioritization.

These QoS features allow network administrators to prioritize mission-critical and bandwidth-intensive traffic, such as enterprise resource planning (ERP) (Oracle, etc.), voice (IP telephony traffic), and computer-aided design (CAD) or computer-aided manufacturing (CAM) over less-time-sensitive applications such as FTP or e-mail. For example, it would be highly undesirable to have a large file download destined to one port on a wiring-closet switch and have quality implications such as increased latency in voice traffic destined to another port on this switch. This condition is avoided by making sure that voice traffic is properly classified and prioritized throughout the network. Other applications, such as Web browsing, can be treated as low priority and handled on a best-effort basis.

The Cisco Catalyst 3560 Series can perform rate limiting through its support of the Cisco Committed Information Rate (CIR) function. Through CIR, bandwidth can be guaranteed in increments as low as 8 kbps. Bandwidth can be allocated based on several criteria, including MAC source address, MAC destination address, IP source address, IP destination address, and TCP or UDP port number. Bandwidth allocation is essential when network environments require service-level agreements or when it is necessary for the network manager to control the bandwidth given to certain users.



## Management

The new Cisco Express Setup feature simplifies the initial configuration of a switch. Users now have the option to set up the switch through a Web browser, eliminating the need for more complex terminal-emulation programs and knowledge of the command-line interface (CLI). Cisco Express Setup reduces the cost of deployment by helping less-skilled personnel quickly and simply set up switches.

Cisco Network Assistant is a PC-based network-management application optimized for LANs of small and medium-sized businesses with up to 250 users. Cisco Network Assistant offers centralized management of Cisco switches, routers, and WLAN access points. It supports a wide range of Cisco Catalyst intelligent switches from Cisco Catalyst 2950 through Cisco Catalyst 4506. Through a user-friendly GUI, users can configure and manage a wide array of switch functions and start the device manager of Cisco routers and Cisco wireless access points. A few mouse clicks enable the Cisco recommended security, availability, and QoS features without the need to consult a detailed design guide. The Security wizard automatically restricts unauthorized access to servers with sensitive data. Smartports and wizards save hours of time for network administrators, eliminate human errors, and help ensure that the configuration of the switch is optimized for these applications. Available at no cost, Cisco Network Assistant can be downloaded from Cisco.com.

In addition to the Cisco Network Assistant, the Cisco Catalyst 3560 Series switches provide for extensive management using SNMP network-management platforms such as CiscoWorks LAN Management Solution (LMS). LMS is a suite of powerful management tools that simplify the configuration, administration, monitoring, and troubleshooting of Cisco networks. It integrates these capabilities into a world-class solution for improving the accuracy and efficiency of your operations staff, while increasing the overall availability of your network. LMS supports over 400 different device types providing:

- Network discovery, topology views, end-station tracking, and VLAN management
- Real-time network fault analysis with easy-to-deploy device specific best-practice templates
- Hardware and software inventory management, centralized configuration tools, and syslog monitoring
- Network response time and availability monitoring and tracking
- Real-time device, link, and port traffic management, analysis, and reporting

### Cisco Catalyst 3560 SFP Interconnect Cable

The Cisco Catalyst 3560 SFP Interconnect Cable (see Figure 2) provides for a low-cost point-to-point Gigabit Ethernet connection between Cisco Catalyst 3560 switches. The 50cm cable is an alternative to using SFP transceivers when interconnecting Cisco Catalyst 3560 switches through their SFP ports over a short distance.

**Figure 2.** Cisco Catalyst 3560 SFP Interconnect Cable

Table 1 gives the features and benefits of the Cisco Catalyst 3560 Series. Table 2 gives the hardware specifications, and Table 3 gives the power specifications. Table 4 lists the management and standards support, and Table 5 provides the safety and compliance information.

**Table 1.** Features and Benefits of Cisco Catalyst 3560 Series

Feature	Benefit
<b>Ease of Use and Deployment</b>	<ul style="list-style-type: none"> <li>• Cisco Express Setup simplifies initial configuration with a Web browser, eliminating the need for more complex terminal emulation programs and CLI knowledge.</li> <li>• IEEE 802.3af and Cisco prestandard PoE support comes with automatic discovery to detect a Cisco prestandard or IEEE 802.3af endpoint and provide the necessary power without any user configuration.</li> <li>• DHCP autoconfiguration of multiple switches through a boot server eases switch deployment.</li> <li>• Automatic QoS (Auto QoS) simplifies QoS configuration in voice-over-IP (VoIP) networks by issuing interface and global switch commands to detect Cisco IP phones, classify traffic, and enable egress queue configuration.</li> <li>• Autosensing on each 10/100 port detects the speed of the attached device and automatically configures the port for 10- or 100-Mbps operation, easing switch deployment in mixed 10- and 100-Mbps environments.</li> <li>• Autonegotiating on all ports automatically selects half- or full-duplex transmission mode to optimize bandwidth.</li> <li>• Dynamic Trunking Protocol (DTP) helps enable dynamic trunk configuration across all switch ports.</li> <li>• Port Aggregation Protocol (PAgP) automates the creation of Cisco Fast EtherChannel<sup>®</sup> groups or Gigabit EtherChannel groups to link to another switch, router, or server.</li> <li>• Link Aggregation Control Protocol (LACP) allows the creation of Ethernet channeling with devices that conform to IEEE 802.3ad. This feature is similar to Cisco EtherChannel technology and PAgP.</li> <li>• DHCP Server enables a convenient deployment option for the assignment of IP addresses in networks that do not have a dedicated DHCP server.</li> <li>• DHCP Relay allows a DHCP relay agent to broadcast DHCP requests to the network DHCP server.</li> <li>• IEEE 802.3z-compliant 1000BASE-SX, 1000BASE-LX/LH, 1000BASE-ZX, 1000BASE-T, and coarse wavelength-division multiplexing (CWDM) physical interface support through a field-replaceable SFP module provides unprecedented flexibility in switch deployment.</li> <li>• Support for the Cisco Catalyst 3560 SFP Interconnect Cable facilitates a low-cost, point-to-point gigabit connection between Cisco Catalyst 3560 Series switches.</li> <li>• The default configuration stored in Flash memory helps ensure that the switch can be quickly connected to the network and can pass traffic with minimal user intervention.</li> <li>• Automatic medium-dependent interface crossover (Auto-MDIX) automatically adjusts transmit and receive pairs if an incorrect cable type (crossover or straight-through) is installed on a 10/100 port.</li> <li>• Time Domain Reflectometry (TDR) to diagnose and resolve cabling problems on copper Ethernet 10/100/1000 ports.</li> </ul>
<b>Cisco EnergyWise</b>	<ul style="list-style-type: none"> <li>• Cisco EnergyWise for greenhouse gas emissions and operational cost optimization by measuring, reporting, and reducing energy consumption across the entire corporate infrastructure, well beyond the scope of IT.</li> </ul>

<b>Availability and Scalability</b>	
<b>Superior Redundancy for Fault Backup</b>	<ul style="list-style-type: none"> <li>• Cisco Uplink Fast and BackboneFast technologies help ensure quick failover recovery, enhancing overall network stability and reliability.</li> <li>• IEEE 802.1w Rapid Spanning Tree Protocol (RSTP) provides rapid spanning-tree convergence independent of spanning-tree timers and the benefit of distributed processing.</li> <li>• Per-VLAN Rapid Spanning Tree Plus (PVRST+) allows rapid spanning-tree reconvergence on a per-VLAN spanning-tree basis, without requiring the implementation of spanning-tree instances.</li> <li>• Cisco Hot Standby Router Protocol (HSRP) is supported to create redundant, fail-safe routing topologies.</li> <li>• Command-switch redundancy enabled in Cisco Network Assistant software allows designation of a backup command switch that takes over cluster-management functions if the primary command switch fails.</li> <li>• Unidirectional Link Detection Protocol (UDLD) and Aggressive UDLD allow unidirectional links to be detected and disabled to avoid problems such as spanning-tree loops.</li> <li>• Switch port autorecovery (errdisable) automatically attempts to reenables a link that is disabled because of a network error.</li> </ul> <ul style="list-style-type: none"> <li>• Cisco RPS 2300 support provides superior internal power-source redundancy, resulting in improved fault tolerance and network uptime.</li> <li>• Equal cost routing (ECR) provides load balancing and redundancy.</li> <li>• Bandwidth aggregation up to 8 Gbps through Cisco Gigabit EtherChannel technology and up to 800 Mbps through Cisco Fast EtherChannel technology enhances fault tolerance and offers higher-speed aggregated bandwidth between switches and to routers and individual servers.</li> </ul>
<b>High-Performance IP Routing</b>	<ul style="list-style-type: none"> <li>• Cisco Express Forwarding hardware routing architecture delivers extremely high-performance IP routing.</li> <li>• Basic IP unicast routing protocols (static, RIPv1, RIPv2 and RIPv6) are supported for small-network routing applications.</li> <li>• Advanced IP unicast routing protocols (OSPF, Interior Gateway Routing Protocol [IGRP], EIGRP, Border Gateway Protocol Version 4 [BGPv4] and IS-ISv4) are supported for load balancing and constructing scalable LANs. The IP Services license is required.</li> <li>• IPv6 routing capability (OSPFv3, EIGRPv6) is supported. IP Services license is required.</li> <li>• Policy-Based Routing (PBR) allows superior control by enabling flow redirection regardless of the routing protocol configured.</li> <li>• Inter-VLAN IP routing provides for full Layer 3 routing between two or more VLANs.</li> <li>• Protocol Independent Multicast (PIM) for IP Multicast routing is supported, including PIM sparse mode (PIM-SM), PIM dense mode (PIM-DM), and PIM sparse-dense mode. The IP Services license is required.</li> <li>• Fallback bridging forwards non-IP traffic between two or more VLANs.</li> </ul>
<b>Integrated Cisco IOS Software Features for Bandwidth Optimization</b>	<ul style="list-style-type: none"> <li>• Per-port broadcast, multicast, and unicast storm control prevents faulty end stations from degrading overall systems performance.</li> <li>• IEEE 802.1d Spanning Tree Protocol support for redundant backbone connections and loop-free networks simplifies network configuration and improves fault tolerance.</li> <li>• PVST+ allows for Layer 2 load sharing on redundant links to efficiently use the extra capacity inherent in a redundant design.</li> <li>• IEEE 802.1s Multiple Spanning Tree Protocol (MSTP) allows a spanning-tree instance per VLAN, enabling Layer 2 load sharing on redundant links.</li> <li>• ECR provides load balancing and redundancy.</li> <li>• VPN routing/forwarding (VRF)-Lite enables a service provider to support two or more VPNs, with overlapping IP addresses.</li> <li>• Local Proxy Address Resolution Protocol (ARP) works in conjunction with Private VLAN Edge to minimize broadcasts and maximize available bandwidth.</li> <li>• VLAN1 minimization allows VLAN1 to be disabled on any individual VLAN trunk link.</li> <li>• VLAN Trunking Protocol (VTP) pruning limits bandwidth consumption on VTP trunks by flooding broadcast traffic only on trunk links required to reach the destination devices.</li> <li>• Internet Group Management Protocol v3 (IGMP) Snooping for IPv4 and IPv6 MLD v1 and v2 Snooping provide fast client joins and leaves of multicast streams and limits bandwidth-intensive video traffic to only the requestors.</li> <li>• IGMP filtering provides multicast authentication by filtering out nonsubscribers and limits the number of concurrent multicast streams available per port.</li> <li>• Multicast VLAN registration (MVR) continuously sends multicast streams in a multicast VLAN while isolating the streams from subscriber VLANs for bandwidth and security reasons.</li> </ul>

<b>QoS and Control</b>	
<b>Advanced QoS</b>	<ul style="list-style-type: none"> <li>• Standard 802.1p CoS and DSCP field classification are provided, using marking and reclassification on a per-packet basis by source and destination IP address, source and destination MAC address, or Layer 4 TCP or UDP port number.</li> <li>• Cisco control- and data-plane QoS ACLs on all ports help ensure proper marking on a per-packet basis.</li> <li>• Four egress queues per port enable differentiated management of up to four traffic types.</li> <li>• SRR scheduling helps ensure differential prioritization of packet flows by intelligently servicing the ingress and egress queues.</li> <li>• Weighted tail drop (WTD) provides congestion avoidance at the ingress and egress queues before a disruption occurs.</li> <li>• Strict priority queuing guarantees that the highest-priority packets are serviced ahead of all other traffic.</li> <li>• There is no performance penalty for highly granular QoS functions.</li> </ul>
<b>Granular Rate Limiting</b>	<ul style="list-style-type: none"> <li>• The Cisco Committed Information Rate (CIR) function guarantees bandwidth in increments as low as 8 kbps.</li> <li>• Rate limiting is provided based on source and destination IP address, source and destination MAC address, Layer 4 TCP and UDP information, or any combination of these fields, using QoS ACLs (IP ACLs or MAC ACLs), class maps, and policy maps.</li> <li>• Asynchronous data flows upstream and downstream from the end station or on the uplink are easily managed using ingress policing and egress shaping.</li> <li>• Up to 64 aggregate or individual policers are available per Fast Ethernet or Gigabit Ethernet port.</li> </ul>
<b>Security</b>	
<b>Networkwide Security Features</b>	<ul style="list-style-type: none"> <li>• IEEE 802.1x allows dynamic, port-based security, providing user authentication.</li> <li>• IEEE 802.1x with VLAN assignment allows a dynamic VLAN assignment for a specific user regardless of where the user is connected.</li> <li>• IEEE 802.1x with voice VLAN permits an IP phone to access the voice VLAN irrespective of the authorized or unauthorized state of the port.</li> <li>• IEEE 802.1x and port security are provided to authenticate the port and manage network access for all MAC addresses, including those of the client.</li> <li>• IEEE 802.1x with an ACL assignment allows for specific identity-based security policies regardless of where the user is connected.</li> <li>• IEEE 802.1x with Guest VLAN allows guests without 802.1x clients to have limited network access on the guest VLAN.</li> <li>• Web authentication for non-802.1x clients allows non-802.1x clients to use an SSL-based browser for authentication.</li> <li>• Multi-Domain Authentication allows an IP phone and a PC to authenticate on the same switch port while placing them on appropriate Voice and Data VLAN.</li> <li>• MAC Auth Bypass (MAB) for voice allows third-party IP phones without an 802.1x supplicant to get authenticated using their MAC address.</li> <li>• Cisco security VLAN ACLs (VACLs) on all VLANs prevent unauthorized data flows from being bridged within VLANs.</li> <li>• Cisco standard and extended IP security router ACLs (RACLs) define security policies on routed interfaces for control- and data-plane traffic.</li> <li>• Port-based ACLs (PACLs) for Layer 2 interfaces allow application of security policies on individual switch ports.</li> <li>• Unicast MAC filtering prevents the forwarding of any type of packet with a matching MAC address.</li> <li>• Unknown unicast and multicast port blocking allows tight control by filtering packets that the switch has not already learned how to forward.</li> <li>• SSHv2, Kerberos, and SNMPv3 provide network security by encrypting administrator traffic during Telnet and SNMP sessions. SSHv2, Kerberos, and the cryptographic version of SNMPv3 require a special cryptographic software image because of U.S. export restrictions.</li> <li>• Private VLAN Edge provides security and isolation between switch ports, helping ensure that users cannot snoop on other users' traffic.</li> <li>• Private VLANs restrict traffic between hosts in a common segment by segregating traffic at Layer 2, turning a broadcast segment into a nonbroadcast multi-access-like segment.</li> <li>• Bidirectional data support on the Switched Port Analyzer (SPAN) port allows the Cisco Secure Intrusion Detection System (IDS) to take action when an intruder is detected.</li> <li>• TACACS+ and RADIUS authentication enable centralized control of the switch and restrict unauthorized users from altering the configuration.</li> <li>• MAC address notification allows administrators to be notified of users added to or removed from the network.</li> <li>• Dynamic ARP Inspection (DAI) helps ensure user integrity by preventing malicious users from exploiting the insecure nature of the ARP protocol.</li> </ul>

	<ul style="list-style-type: none"> <li>• DHCP snooping allows administrators to help ensure consistent mapping of IP to MAC addresses. This can be used to prevent attacks that attempt to poison the DHCP binding database, and to rate limit the amount of DHCP traffic that enters a switch port.</li> <li>• IP source guard prevents a malicious user from spoofing or taking over another user's IP address by creating a binding table between the client's IP and MAC address, port, and VLAN.</li> <li>• DHCP Interface Tracker (Option 82) augments a host IP address request with the switch port ID.</li> <li>• Port security secures the access to an access or trunk port based on MAC address.</li> <li>• After a specific timeframe, the aging feature removes the MAC address from the switch to allow another device to connect to the same port.</li> <li>• Trusted Boundary provides the ability to trust the QoS priority settings if an IP phone is present and to disable the trust setting if the IP phone is removed, thereby preventing a malicious user from overriding prioritization policies in the network.</li> <li>• Multilevel security on console access prevents unauthorized users from altering the switch configuration.</li> <li>• The user-selectable address-learning mode simplifies configuration and enhances security.</li> <li>• BPDU Guard shuts down Spanning Tree Protocol PortFast-enabled interfaces when BPDUs are received to avoid accidental topology loops.</li> <li>• Spanning-Tree Root Guard (STRG) prevents edge devices not in the network administrator's control from becoming Spanning Tree Protocol root nodes.</li> <li>• IGMP filtering provides multicast authentication by filtering out nonsubscribers and limits the number of concurrent multicast streams available per port.</li> <li>• Dynamic VLAN assignment is supported through implementation of VLAN Membership Policy Server (VMPS) client functions to provide flexibility in assigning ports to VLANs. Dynamic VLAN helps enable the fast assignment of IP addresses.</li> <li>• Cisco Network Assistant software security wizards ease the deployment of security features for restricting user access to a server as well as to a portion of or the entire network.</li> <li>• Two thousand access control entries (ACEs) are supported.</li> </ul>
<b>Manageability</b>	
<b>Superior Manageability</b>	<ul style="list-style-type: none"> <li>• Cisco IOS CLI support provides a common user interface and command set with all Cisco routers and Cisco Catalyst desktop switches.</li> <li>• Cisco Discovery Protocol version 2 (CDPv2) allows the Cisco Catalyst 3560 Series Switch to negotiate a more granular power setting when connecting to a Cisco powered device, such as IP phones or access points, than what is provided by IEEE classification.</li> <li>• The PoE MIB provides proactive visibility into power usage and allows customers to set different power level thresholds.</li> <li>• Switching Database Manager templates for access, routing, and VLAN deployment scenarios allow the administrator to easily maximize memory allocation to the desired features based on deployment-specific requirements.</li> <li>• Generic On-Line Diagnostic (GOLD) checks the health of hardware components and verifies proper operation of the system data and control plane at run time and boot time.</li> <li>• VLAN trunks can be created from any port, using either standards-based 802.1Q tagging or the Cisco Inter-Switch Link (ISL) VLAN architecture.</li> <li>• Up to 1024 VLANs and up to 128 spanning-tree instances per switch are supported.</li> <li>• Four thousand VLAN IDs are supported.</li> <li>• Voice VLAN simplifies telephony installations by keeping voice traffic on a separate VLAN for easier administration and troubleshooting.</li> <li>• Cisco VTP supports dynamic VLANs and dynamic trunk configuration across all switches.</li> <li>• IGMPv3 snooping provides fast client joins and leaves of multicast streams and limits bandwidth-intensive video traffic to only the requestors.</li> <li>• Remote SPAN (RSPAN) allows administrators to remotely monitor ports in a Layer 2 switch network from any other switch in the same network.</li> <li>• For enhanced traffic management, monitoring, and analysis, the Embedded Remote Monitoring (RMON) software agent supports four RMON groups (history, statistics, alarms, and events).</li> <li>• Layer 2 traceroute eases troubleshooting by identifying the physical path that a packet takes from source to destination.</li> <li>• All nine RMON groups are supported through a SPAN port, which permits traffic monitoring of a single port, a group of ports from a single network analyzer or RMON probe.</li> <li>• Domain Name System (DNS) provides IP address resolution with user-defined device names.</li> <li>• Trivial File Transfer Protocol (TFTP) reduces the cost of administering software upgrades by downloading from a centralized location.</li> <li>• Network Timing Protocol (NTP) provides an accurate and consistent timestamp to all intranet switches.</li> </ul>

	<ul style="list-style-type: none"> <li>• Multifunction LEDs per port for port status; half-duplex and full-duplex mode; and 10BASE-T, 100BASE-TX, and 1000BASE-T indication as well as switch-level status LEDs for system, redundant power supply, and bandwidth use provide a comprehensive and convenient visual management system.</li> </ul>
<b>Cisco Network Assistant Software</b>	<ul style="list-style-type: none"> <li>• Cisco Network Assistant is a free, Windows-based application that simplifies the administration of networks of up to 250 users. It supports a wide range of Cisco Catalyst intelligent switches from Cisco Catalyst 2950 through Cisco Catalyst 4506. With Cisco Network Assistant, users can manage Cisco Catalyst switches plus launch the device managers of Cisco integrated services routers (ISRs) and Cisco Aironet WLAN access points.</li> <li>• The easy-to-use graphical interface provides both a topology map and front-panel view of the switch.</li> <li>• Cisco AVVID (Architecture for Voice, Video and Integrated Data) wizards need just a few user inputs to automatically configure the switch to optimally handle different types of traffic: voice, video, multicast, and high-priority data.</li> <li>• A security wizard is provided to restrict unauthorized access to applications, servers, and networks.</li> <li>• Upgrading the Cisco IOS Software on Cisco Catalyst switches is a simple matter of pointing and clicking, with one-click upgrades.</li> <li>• Cisco Network Assistant supports multilayer feature configurations such as routing protocols, ACLs, and QoS parameters.</li> <li>• Multidevice and multipoint configuration capabilities allow administrators to save time by configuring features across multiple switches and ports simultaneously.</li> <li>• The user-personalized interface allows modification of polling intervals, table views, and other settings.</li> <li>• Alarm notification provides automated e-mail notification of network errors and alarm thresholds.</li> </ul>
<b>Cisco Express Setup</b>	<ul style="list-style-type: none"> <li>• Cisco Express Setup simplifies initial configuration of a switch through a Web browser, eliminating the need for more complex terminal emulation programs and CLI knowledge.</li> <li>• The Web interface helps less-skilled personnel quickly and simply set up switches, thereby reducing the cost of deployment.</li> </ul>
<b>CiscoWorks Support</b>	<ul style="list-style-type: none"> <li>• CiscoWorks network-management software provides management capabilities on a per-port and per-switch basis, providing a common management interface for Cisco routers, switches, and hubs.</li> <li>• SNMP v1, v2c, and v3 and Telnet interface support delivers comprehensive in-band management, and a CLI-based management console provides detailed out-of-band management.</li> <li>• Cisco Discovery Protocol Versions 1 and 2 help enable a CiscoWorks network-management station for automatic switch discovery.</li> <li>• The CiscoWorks LAN Management Solution supports the Cisco Catalyst 3560 Series.</li> </ul>

**Table 2.** Cisco Catalyst 3560 Series Switch Hardware

Description	Specification
<b>Performance</b>	<ul style="list-style-type: none"> <li>• 32 Gbps forwarding bandwidth</li> <li>• Forwarding rate based on 64-byte packets:</li> <li>• 38.7 Mpps (Cisco Catalyst 3560G-48TS, Catalyst 3560G-48PS, Catalyst 3560G-24TS, and Catalyst 3560G-24PS);</li> <li>• 13.1 Mpps (Cisco Catalyst 3560-48TS and Catalyst 3560-48PS);</li> <li>• 6.5 Mpps (Cisco Catalyst 3560-24TS and Catalyst 3560-24PS);</li> <li>• 3.2 Mpps (Cisco Catalyst 3560-12PC)</li> <li>• 2.7 Mpps (Cisco Catalyst 3560-8PC)</li> <li>• 128 MB DRAM</li> <li>• 32 MB Flash memory (Cisco Catalyst 3560G-24TS, Catalyst 3560G-24PS, Catalyst 3560G-48TS, Catalyst 3560G-48PS, Catalyst 3560-24TS, Catalyst 3560-48TS, and Catalyst 3560-8PC);</li> <li>• 16-MB Flash memory (Cisco Catalyst 3560-48PS and Catalyst 3560-24PS)</li> <li>• Configurable up to 12,000 MAC addresses</li> <li>• Configurable up to 11,000 unicast routes</li> <li>• Configurable up to 1000 IGMP groups and multicast routes</li> <li>• Configurable maximum transmission unit (MTU) of up to 9000 bytes, with a maximum Ethernet frame size of 9018 bytes (Jumbo frames), for bridging on Gigabit Ethernet ports, and up to 1546 bytes for bridging of Multiprotocol Label Switching (MPLS) tagged frames on 10/100 ports</li> </ul>
<b>Connectors and Cabling</b>	<ul style="list-style-type: none"> <li>• 10BASE-T ports: RJ-45 connectors, two-pair Category 3, 4, or 5 unshielded twisted-pair (UTP) cabling</li> <li>• 10BASE-T PoE ports: RJ-45 connectors, two-pair Category 3, 4, or 5 UTP cabling power pins 1,2 (negative) and 3,6 (positive)</li> </ul>



	<ul style="list-style-type: none"> <li>• 100BASE-TX ports: RJ-45 connectors, two-pair Category 5 UTP cabling</li> <li>• 100BASE-TX PoE ports: RJ-45 connectors, two-pair Category 5 UTP cabling, power on pins 1,2 (negative) and 3,6 (positive)</li> <li>• 1000BASE-T ports: RJ-45 connectors, four-pair Category 5 UTP cabling</li> <li>• 1000BASE-T SFP-based ports: RJ-45 connectors, four-pair Category 5 UTP cabling</li> <li>• 1000BASE-SX, -LX/LH, -ZX, and CWDM SFP-based ports: LC fiber connectors (single/multimode fiber)</li> <li>• Cisco Catalyst 3560 SFP Interconnect Cable: two-pair shielded cabling, 50 cm</li> <li>• Management console port: RJ-45-to-DB-9 cable for PC connections; for terminal connections, use RJ-45-to-DB-25 female data-terminal-equipment (DTE) adaptor (can be ordered separately from Cisco; part number ACS-DSBUASYN=)</li> </ul>
<b>Power Connectors</b>	<ul style="list-style-type: none"> <li>• Customers can provide power to a switch by using either the internal power supply or the Cisco RPS 2300. The connectors are located at the back of the switch. Note: The Cisco Catalyst 3560-8PC and Catalyst 3560-12PC do not have an RPS port.</li> <li>• Internal-Power-Supply Connector</li> <li>• The internal power supply is an autoranging unit.</li> <li>• The internal power supply supports input voltages between 100 and 240 VAC.</li> <li>• Use the supplied AC power cord to connect the AC power connector to an AC power outlet.</li> <li>• Cisco RPS Connector</li> <li>• The connector offers connection for an optional Cisco RPS 2300 that uses AC input and supplies DC output to the switch.</li> <li>• The connector supports up to six external network devices and provides power to two failed devices at a time.</li> <li>• The connector automatically senses when the internal power supply of a connected device fails and provides power to the failed device, preventing loss of network traffic.</li> <li>• Only the Cisco RPS 2300 (model PWR-RPS2300) should be attached to the redundant-power-supply receptacle.</li> </ul>
<b>Indicators</b>	<ul style="list-style-type: none"> <li>• Per-port status LEDs: Link integrity, disabled, activity, speed, full-duplex indications, PoE applied, PoE error, and PoE disabled indications</li> <li>• System-status LEDs: System, RPS, link status, link duplex, link speed, and PoE indications</li> </ul>
<b>Dimensions (H x W x D)</b>	<ul style="list-style-type: none"> <li>• Cisco Catalyst 3560-8PC: 1.73 x 10.6 x 9.1 in. (4.4 x 27 x 23 cm)</li> <li>• Cisco Catalyst 3560-12PC: 1.73 x 10.6 x 9.1 in. (4.4 x 27 x 23 cm)</li> <li>• Cisco Catalyst 3560-24TS: 1.73 x 17.5 x 11.8 in. (4.4 x 44.5 x 30 cm)</li> <li>• Cisco Catalyst 3560-48TS: 1.73 x 17.5 x 11.8 in. (4.4 x 44.5 x 30 cm)</li> <li>• Cisco Catalyst 3560-24PS: 1.73 x 17.5 x 11.8 in. (4.4 x 44.5 x 30 cm)</li> <li>• Cisco Catalyst 3560-48PS: 1.73 x 17.5 x 14.9 in. (4.4 x 44.5 x 37.8 cm)</li> <li>• Cisco Catalyst 3560G-24TS: 1.73 x 17.5 x 14.9 in. (4.4 x 44.5 x 37.8 cm)</li> <li>• Cisco Catalyst 3560G-48TS: 1.73 x 17.5 x 16.1 in. (4.4 x 44.5 x 40.9 cm)</li> <li>• Cisco Catalyst 3560G-24PS: 1.73 x 17.5 x 14.9 in. (4.4 x 44.5 x 37.8 cm)</li> <li>• Cisco Catalyst 3560G-48PS: 1.73 x 17.5 x 16.1 in. (4.4 x 44.5 x 40.9 cm)</li> </ul>
<b>Weight</b>	<ul style="list-style-type: none"> <li>• Cisco Catalyst 3560-8PC: 5 lb (2.3 kg)</li> <li>• Cisco Catalyst 3560-12PC: 5 lb (2.3 kg)</li> <li>• Cisco Catalyst 3560-24TS: 8.5 lb (3.9 kg)</li> <li>• Cisco Catalyst 3560-48TS: 9.1 lb (4.1 kg)</li> <li>• Cisco Catalyst 3560-24PS: 11.3 lb (5.1 kg)</li> <li>• Cisco Catalyst 3560-48PS: 13.2 lb (6.0 kg)</li> <li>• Cisco Catalyst 3560G-24TS: 12 lb (5.4 kg)</li> <li>• Cisco Catalyst 3560G-24PS: 13.5 lb (6.1 kg)</li> <li>• Cisco Catalyst 3560G-48TS: 14.0 lb (6.4 kg)</li> <li>• Cisco Catalyst 3560G-48PS: 15.5 lb (7.0 kg)</li> </ul>
<b>Environmental Ranges</b>	<ul style="list-style-type: none"> <li>• Operating temperature: 32 to 113°F (0 to 45°C)</li> <li>• Storage temperature: -13 to 158°F (-25 to 70°C)</li> <li>• Operating relative humidity: 10 to 85% (noncondensing)</li> <li>• Operating altitude: Up to 10,000 ft (3049m)</li> <li>• Storage altitude: Up to 15,000 ft (4573m)</li> </ul>
<b>Acoustic Noise</b>	<ul style="list-style-type: none"> <li>• ISO 7779: Bystander position operating to an ambient temperature of 25°C</li> <li>• Cisco Catalyst 3560-8PC: 0 dBa (no fan)</li> <li>• Cisco Catalyst 3560-12PC: 0 dBa (no fan)</li> <li>• Cisco Catalyst 3560-24TS: 42 dBa</li> <li>• Cisco Catalyst 3560-48TS: 42 dBa</li> <li>• Cisco Catalyst 3560-24PS: 42 dBa</li> </ul>

	<ul style="list-style-type: none"> <li>• Cisco Catalyst 3560-48PS: 42 dBa</li> <li>• Cisco Catalyst 3560G-24TS: 42 dBa</li> <li>• Cisco Catalyst 3560G-48TS: 48 dBa</li> <li>• Cisco Catalyst 3560G-24PS: 38-44 dBa</li> <li>• Cisco Catalyst 3560G-48PS: 52-58 dBa</li> </ul>
<b>Mean Time Between Failure (MTBF)</b>	<ul style="list-style-type: none"> <li>• Cisco Catalyst 3560-8PC: 367,586 hours</li> <li>• Cisco Catalyst 3560-12PC: 406,470 hours</li> <li>• Cisco Catalyst 3560-24TS: 326,100 hours</li> <li>• Cisco Catalyst 3560-48TS: 280,900 hours</li> <li>• Cisco Catalyst 3560-24PS: 224,100 hours</li> <li>• Cisco Catalyst 3560-48PS: 173,500 hours</li> <li>• Cisco Catalyst 3560G-24TS: 230,700 hours</li> <li>• Cisco Catalyst 3560G-24PS: 186,300 hours</li> <li>• Cisco Catalyst 3560G-48TS: 173,400 hours</li> <li>• Cisco Catalyst 3560G-48PS: 147,000 hours</li> </ul>

**Table 3.** Power Specifications for Cisco Catalyst 3560 Series Switch

Description	Specification		
<b>Power Supply Rated Maximum</b>	<ul style="list-style-type: none"> <li>• 204W (Cisco Catalyst 3560-8PC, Catalyst 3560-12PC)</li> <li>• Dissipated power: 80W, 273 BTUs per hour</li> <li>• PoE: 124W</li> <li>• 45W (Cisco Catalyst 3560-24TS)</li> <li>• 485W (Cisco Catalyst 3560-24PS)</li> <li>• Dissipated power: 115W, 393 BTUs per hour</li> <li>• PoE: 370W</li> <li>• 65W (Cisco Catalyst 3560-48TS)</li> <li>• 530W (Cisco Catalyst 3560-48PS)</li> <li>• Dissipated power: 160W, 546 BTUs per hour</li> <li>• PoE: 370W</li> <li>• 100W (Cisco Catalyst 3560G-24TS)</li> <li>• 540W (Cisco Catalyst 3560G-24PS)</li> <li>• Dissipated power: 170W, 534 BTUs per hour</li> <li>• PoE: 370W</li> <li>• 160W (Cisco Catalyst 3560G-48TS)</li> <li>• 590W (Cisco Catalyst 3560G-48PS)</li> <li>• Dissipated power: 220W, 690 BTUs per hour</li> <li>• PoE: 370W</li> </ul>		
<b>Measured 100% Throughput Power Consumption</b>	<b>Cisco Catalyst 3560 Series</b>	<b>Switch Power</b>	<b>Total Output BTU</b>
	3560-8PC	19W	64 BTU/hour
	3560-12PC	22W	73 BTU/hour
	3560-24TS	27W	89 BTU/hour
	3560-48TS	45W	153 BTU/hour
	3560-24PS	43W	144 BTU/hour
	3560-48PS	86W	293 BTU/hour
	3560G-24TS	74W	249 BTU/hour
	3560G-24PS	96W	325 BTU/hour
	3560G-48TS	124W	422 BTU/hour
3560G-48PS	130W	443 BTU/hour	
<b>Measured 5% Throughput Power Consumption</b>	<b>Cisco Catalyst 3560 Series</b>	<b>Switch Power</b>	<b>Total Output BTU</b>
	3560-8PC	18W	60 BTU/hour
	3560-12PC	20W	68 BTU/hour
	3560-24TS	24W	82 BTU/hour
	3560-48TS	41W	138 BTU/hour
	3560-24PS	40W	134 BTU/hour



	3560-48PS	72W	245 BTU/hour	
	3560G-24TS	66W	225 BTU/hour	
	3560G-24PS	86W	293 BTU/hour	
	3560G-48TS	113W	386 BTU/hour	
	3560G-48PS	123W	418 BTU/hour	
<b>Measured 100% Throughput Power Consumption (with maximum possible PoE loads)</b>	<b>Cisco Catalyst 3560 Series</b>	<b>Switch Power</b>	<b>PoE Power</b>	<b>Total Output BTU</b>
	3560-8PC	145W	124W	70 BTU/hour
	3560-12PC	145W	124W	72 BTU/hour
	3560-24PS	449W	370W	267 BTU/hour
	3560-48PS	483W	370W	383 BTU/hour
	3560G-24PS	496W	370W	429 BTU/ hour
	3560G-48PS	534W	370W	559 BTU/hour
<b>Measured 5% Throughput Power Consumption (with 50% PoE loads)</b>	<b>Cisco Catalyst 3560 Series</b>	<b>Switch Power</b>	<b>PoE Power</b>	<b>Total Output BTU</b>
	3560-8PC	82W	62W	69 BTU/hour
	3560-12PC	86W	63W	76 BTU/hour
	3560-24PS	247W	188W	197 BTU/hour
	3560-48PS	275W	184W	311 BTU/hour
	3560G-24PS	287W	186W	345 BTU/ hour
	3560G-48PS	328W	189	474 BTU/hour
<b>AC Input Voltage and Current</b>	<ul style="list-style-type: none"> <li>• 100-240 VAC (autoranging), 2.5-1.3A, 50-60 Hz (Cisco Catalyst 3560-8PC)</li> <li>• 100-240 VAC (autoranging), 2.5-1.3A, 50-60 Hz (Cisco Catalyst 3560-12PC)</li> <li>• 100-240 VAC (autoranging), 450-190mA, 50-60 Hz (Cisco Catalyst 3560-24TS)</li> <li>• 100-240 VAC (autoranging), 650-270mA, 50-60 Hz (Cisco Catalyst 3560-48TS)</li> <li>• 100-240 VAC (autoranging), 5.5-2.8A, 50-60 Hz (Cisco Catalyst 3560-24PS and Catalyst 3560-48PS)</li> <li>• 100-240 VAC (autoranging), 3.0-1.5A, 50-60Hz (Cisco Catalyst 3560G-24TS and Catalyst 3560G-48TS)</li> <li>• 100-240 VAC (autoranging), 8.0-4.0A, 50-60Hz (Cisco Catalyst 3560G-24PS and Catalyst 3560G-48PS)</li> </ul>			
<b>Power Rating</b>	<ul style="list-style-type: none"> <li>• Cisco Catalyst 3560-8PC: 0.2 kVA</li> <li>• Cisco Catalyst 3560-12PC: 0.2 kVA</li> <li>• Cisco Catalyst 3560-24TS: 0.075 kVA</li> <li>• Cisco Catalyst 3560-48TS: 0.110 kVA</li> <li>• Cisco Catalyst 3560-24PS: 0.485 kVA</li> <li>• Cisco Catalyst 3560-48PS: 0.530 kVA</li> <li>• Cisco Catalyst 3560G-24TS: 0.10 kVA</li> <li>• Cisco Catalyst 3560G-48TS: 0.16 kVA</li> <li>• Cisco Catalyst 3560G-24PS: 0.52 kVA</li> <li>• Cisco Catalyst 3560G-48PS: 0.56 kVA</li> </ul>			
<b>DC Input Voltages (RPS Input)</b>	<ul style="list-style-type: none"> <li>• +12V at 5A (Cisco Catalyst 3560-24TS and Catalyst 3560-48TS); 7.5A (Cisco Catalyst 3560-24PS and Catalyst 3560-48PS); 10.5A (Cisco Catalyst 3560G-24TS); 17.5A (Cisco Catalyst 3560G-48TS); 14A (Cisco Catalyst 3560G-24PS and Catalyst 3560G-48PS)</li> <li>• -48V at 7.8A (PoE switches)</li> </ul>			
<b>PoE</b>	<ul style="list-style-type: none"> <li>• Maximum power supplied per port: 15.4W</li> <li>• Total power dedicated to PoE: 370W</li> <li>• Total power dedicated to PoE: 124W (Cisco Catalyst 3560-8PC, Catalyst 3560-12PC)</li> </ul>			

**Note:**

Disclaimer: All power consumption numbers were measured under controlled laboratory conditions and are provided as an estimate.

The wattage rating on the power supply does not represent actual power draw. It indicates the maximum power draw possible by the power supply. This rating can be used for facility capacity

planning. For PoE switches, cooling requirements are smaller than the actual power consumption as a significant portion of PoE loads are dissipated in the endpoints.

### **Non-PoE Power Consumption**

#### 100 Percent Throughput Switch Power Consumption

The numbers indicate the power consumed by a typical switch under normal conditions. Normal conditions signify a temperature of 25 degrees Celsius, atmospheric pressure in the range of 860 to 1060 mbar, and relative humidity from 30 to 75 percent. Typically such power draws are only seen when encountering a 100 percent traffic load made up entirely of 64-byte packets on the switch and the uplinks.

#### 5 Percent Throughput Switch Power Consumption

The numbers indicate the power consumed by a typical switch under normal conditions. Normal conditions signify a temperature of 25 degrees Celsius, atmospheric pressure in the range of 860 to 1060 mbar, and relative humidity from 30 to 75 percent. The numbers below indicate a 5 percent traffic load on the switch and its uplinks.

### **PoE Power Consumption**

#### 100 Percent Throughput Switch Power Consumption (no PoE loads)

The numbers indicate the power consumed by a typical switch under normal conditions. Normal conditions signify a temperature of 25 degrees Celsius, atmospheric pressure in the range of 860 to 1060 mbar, and relative humidity from 30 to 75 percent. Typically such power draws are only seen when encountering a 100 percent traffic load made up entirely of 64-byte packets with no PoE loads on the switch and uplinks.

#### Measured 5 Percent Throughput Switch Power Consumption (no PoE loads)

The numbers indicate the power consumed by a typical switch under normal conditions. Normal conditions signify a temperature of 25 degrees Celsius, atmospheric pressure in the range of 860 to 1060 mbar and relative humidity from 30 to 75 percent. The numbers below indicate a 5 percent traffic load on the switch and its uplinks

#### 100 Percent Throughput Switch Power Consumption (with maximum PoE loads)

The numbers indicate the power consumed by a typical system (the switch and the corresponding PoE loads) under normal conditions. Normal conditions signify a temperature of 25 degrees Celsius, atmospheric pressure in the range of 860 to 1060 mbar and relative humidity from 30 to 75 percent. Typically this power draw is realized when a switch is running 100 percent traffic load of 64 byte sized packets on all its ports and uplinks and also drawing 100 percent PoE load .

#### 5 Percent Throughput Switch Power Consumption (with 50 percent PoE loads).

The numbers indicate the power consumed by a typical system (the switch and the corresponding PoE loads) under normal conditions. Normal conditions signify a temperature of 25 degrees Celsius, atmospheric pressure in the range of 860 to 1060 mbar and relative humidity from 30 to 75 percent. The numbers below indicate a 5 percent traffic load and 50 percent PoE load on the switch and its uplinks.

**Table 4.** Management and Standards Support for Cisco Catalyst 3560 Series Switch

Description	Specification	
<b>Management</b>	<ul style="list-style-type: none"> <li>• BRIDGE-MIB</li> <li>• CISCO-CDP-MIB</li> <li>• CISCO-CLUSTER-MIB</li> <li>• CISCO-CONFIG-MAN-MIB</li> <li>• CISCO-ENTITY-FRU-CONTROL-MIB</li> <li>• CISCO-ENVMON-MIB</li> <li>• CISCO-FLASH-MIB</li> <li>• CISCO-FTP-CLIENT-MIB</li> <li>• CISCO-HSRP-MIB</li> <li>• CISCO-HSRP-EXT-MIB</li> <li>• CISCO-IGMP-FILTER-MIB</li> <li>• CISCO-IMAGE-MIB</li> <li>• CISCO-IP-STAT-MIB</li> <li>• CISCO-L2L3-INTERFACE-CONFIG-MIB</li> <li>• CISCO-MAC-NOTIFICATION-MIB</li> <li>• CISCO-MEMORY-POOL-MIB</li> <li>• CISCO-PAGP-MIB</li> <li>• CISCO-PING-MIB</li> <li>• CISCO-PROCESS-MIB</li> <li>• CISCO-RTTMON-MIB</li> <li>• CISCO-STP-EXTENSIONS-MIB</li> <li>• CISCO-SYSLOG-MIB</li> <li>• CISCO-TCP-MIB</li> <li>• CISCO-VLAN-IFTABLE-RELATIONSHIP-MIB</li> <li>• CISCO-VLAN-MEMBERSHIP-MIB</li> </ul>	<ul style="list-style-type: none"> <li>• CISCO-VTP-MIB</li> <li>• ENTITY-MIB</li> <li>• ETHERLIKE-MIB</li> <li>• IF-MIB</li> <li>• IGMP-MIB</li> <li>• IPMROUTE-MIB</li> <li>• OLD-CISCO-CHASSIS-MIB</li> <li>• OLD-CISCO-FLASH-MIB</li> <li>• OLD-CISCO-INTERFACES-MIB</li> <li>• OLD-CISCO-IP-MIB</li> <li>• OLD-CISCO-SYS-MIB</li> <li>• OLD-CISCO-TCP-MIB</li> <li>• OLD-CISCO-TS-MIB</li> <li>• OSPF-MIB (RFC 1253)</li> <li>• PIM-MIB</li> <li>• RFC1213-MIB</li> <li>• RFC1253-MIB</li> <li>• RMON-MIB</li> <li>• RMON2-MIB</li> <li>• SNMP-FRAMEWORK-MIB</li> <li>• SNMP-MPD-MIB</li> <li>• SNMP-NOTIFICATION-MIB</li> <li>• SNMP-TARGET-MIB</li> <li>• SNMPv2-MIB</li> <li>• TCP-MIB</li> <li>• UDP-MIB</li> </ul>
<b>Standards</b>	<ul style="list-style-type: none"> <li>• IEEE 802.1s</li> <li>• IEEE 802.1w</li> <li>• IEEE 802.1x</li> <li>• IEEE 802.3ad</li> <li>• IEEE 802.3af</li> <li>• IEEE 802.3x full duplex on 10BASE-T, 100BASE-TX, and 1000BASE-T ports</li> <li>• IEEE 802.1D Spanning Tree Protocol</li> <li>• IEEE 802.1p CoS Prioritization</li> <li>• IEEE 802.1Q VLAN</li> <li>• IEEE 802.3 10BASE-T specification</li> <li>• IEEE 802.3u 100BASE-TX specification</li> <li>• IEEE 802.3ab 1000BASE-T specification</li> <li>• IEEE 802.3z 1000BASE-X specification</li> </ul>	<ul style="list-style-type: none"> <li>• 1000BASE-X (SFP)</li> <li>• 1000BASE-SX</li> <li>• 1000BASE-LX/LH</li> <li>• 1000BASE-ZX</li> <li>• 1000BASE-CWDM SFP 1470 nm</li> <li>• 1000BASE-CWDM SFP 1490 nm</li> <li>• 1000BASE-CWDM SFP 1510 nm</li> <li>• 1000BASE-CWDM SFP 1530 nm</li> <li>• 1000BASE-CWDM SFP 1550 nm</li> <li>• 1000BASE-CWDM SFP 1570 nm</li> <li>• 1000BASE-CWDM SFP 1590 nm</li> <li>• 1000BASE-CWDM SFP 1610 nm</li> <li>• RMON I and II standards</li> <li>• SNMPv1, SNMPv2c, and SNMPv3</li> </ul>

**Table 5.** Safety and Compliance

Description	Specification
<b>Safety Certifications</b>	<ul style="list-style-type: none"> <li>• UL 60950-1, First Edition</li> <li>• CUL to CAN/CSA 22.2 No. 60950-1, First Edition</li> <li>• TUV/GS to EN 60950-1, First Edition</li> <li>• CB to IEC 60950-1 with all country deviations</li> <li>• AS/NZS 60950-1, First Edition</li> <li>• NOM (through partners and distributors)</li> <li>• CE Marking</li> </ul>
<b>Electromagnetic Emissions Certifications</b>	<ul style="list-style-type: none"> <li>• FCC Part 15 Class A</li> <li>• EN 55022 Class A (CISPR22)</li> <li>• EN 55024 (CISPR24)</li> <li>• AS/NZS CISPR22 Class A</li> <li>• CE</li> <li>• CNS 13438 Class A</li> </ul>

	<ul style="list-style-type: none"> <li>• MIC</li> <li>• GOST</li> <li>• China EMC Certifications</li> </ul>
<b>Telco</b>	Common Language Equipment Identifier (CLEI) code
<b>Warranty</b>	Limited lifetime warranty

## Cisco Services for Access Switching

Cisco and our partners can help you create a robust, dependable Cisco Access Switching solution. The Cisco lifecycle approach to services defines the requisite activities at each phase of the solution lifecycle. Assessments help align your solution to business goals and gauge readiness to support new technology. Effective planning and design expedite solution adoption. Award-winning technical support increases operational efficiency, and optimization improves performance, resiliency, stability, and predictability and prepares your network and teams for change. For more information, visit <http://www.cisco.com/go/services>.

**Table 6.** Cisco Services and Support Programs

Service and Support	Features	Benefits
<b>Advanced Services</b>		
<ul style="list-style-type: none"> <li>• Cisco Total Implementation Solutions (TIS), available direct from Cisco</li> <li>• Cisco Packaged TIS, available through resellers</li> <li>• Cisco SMARTnet<sup>®</sup> and SMARTnet Onsite support, available direct from Cisco</li> <li>• Cisco Packaged SMARTnet support program, available through resellers</li> </ul>	<ul style="list-style-type: none"> <li>• Project management</li> <li>• Site survey, configuration, and deployment</li> <li>• Installation, text, and cutover</li> <li>• Training</li> <li>• Major moves, adds, and changes</li> <li>• Design review and product staging</li> <li>• Access to software updates 24 hours</li> <li>• Web access to technical repositories</li> <li>• Telephone support through the Cisco Technical Assistance Center (TAC)</li> <li>• Advance Replacement of hardware parts</li> </ul>	<ul style="list-style-type: none"> <li>• Supplements existing staff</li> <li>• Helps ensure that functions meet needs</li> <li>• Mitigates risk</li> <li>• Helps enable proactive or expedited issue resolution</li> <li>• Lowers TCO by taking advantage of Cisco expertise and knowledge</li> <li>• Minimizes network downtime</li> </ul>

## Ordering Information

Table 7 gives ordering information for the Cisco Catalyst 3560 Series switches.

**Table 7.** Ordering Information for Cisco Catalyst 3560 Series Switches

Part Numbers	Description
<b>WS-C3560-8PC-S</b>	<ul style="list-style-type: none"> <li>• 8 Ethernet 10/100 ports and 1 dual-purpose 10/100/1000 and SFP port</li> <li>• Compact form-factor with no fan</li> <li>• Enterprise-class intelligent services delivered to the network edge</li> <li>• IEEE 802.3af and Cisco prestandard Power over Ethernet</li> <li>• IP Base software feature set (IPB)</li> </ul>
<b>WS-C3560-12PC-S</b>	<ul style="list-style-type: none"> <li>• 12 Ethernet 10/100 ports and 1 dual-purpose 10/100/1000 and SFP port</li> <li>• Compact form-factor with no fan</li> <li>• Enterprise-class intelligent services delivered to the network edge</li> <li>• IEEE 802.3af and Cisco prestandard Power over Ethernet</li> <li>• IP Base software feature set (IPB)</li> </ul>
<b>WS-C3560-24TS-S</b>	<ul style="list-style-type: none"> <li>• 24 Ethernet 10/100 ports and 2 SFP-based Gigabit Ethernet ports</li> <li>• 1RU fixed-configuration, multilayer switch</li> <li>• Enterprise-class intelligent services delivered to the network edge</li> <li>• IP Base software feature set (IPB)</li> </ul>
<b>WS-C3560-24TS-E</b>	<ul style="list-style-type: none"> <li>• 24 Ethernet 10/100 ports and 2 SFP-based Gigabit Ethernet ports</li> <li>• RU fixed-configuration, multilayer switch</li> </ul>

	<ul style="list-style-type: none"> <li>Enterprise-class intelligent services delivered to the network edge</li> <li>IP Services software feature set (IPS)</li> <li>Provides full IPv6 dynamic routing</li> </ul>
<b>WS-C3560-48TS-S</b>	<ul style="list-style-type: none"> <li>48 Ethernet 10/100 ports and 4 SFP-based Gigabit Ethernet ports</li> <li>1RU fixed-configuration, multilayer switch</li> <li>Enterprise-class intelligent services delivered to the network edge</li> <li>IP Base software feature set (IPB)</li> </ul>
<b>WS-C3560-48TS-E</b>	<ul style="list-style-type: none"> <li>48 Ethernet 10/100 ports and 4 SFP-based Gigabit Ethernet ports</li> <li>1RU fixed-configuration, multilayer switch</li> <li>Enterprise-class intelligent services delivered to the network edge</li> <li>IP Services software feature set (IPS)</li> <li>Provides full IPv6 dynamic routing</li> </ul>
<b>WS-C3560-24PS-S</b>	<ul style="list-style-type: none"> <li>24 Ethernet 10/100 ports and 2 SFP-based Gigabit Ethernet ports</li> <li>1RU fixed-configuration, multilayer switch</li> <li>Enterprise-class intelligent services delivered to the network edge</li> <li>IEEE 802.3af and Cisco prestandard Power over Ethernet</li> <li>IP Base software feature set (IPB)</li> </ul>
<b>WS-C3560-24PS-E</b>	<ul style="list-style-type: none"> <li>24 Ethernet 10/100 ports and 2 SFP-based Gigabit Ethernet ports</li> <li>1RU fixed-configuration, multilayer switch</li> <li>Enterprise-class intelligent services delivered to the network edge</li> <li>IEEE 802.3af and Cisco prestandard Power over Ethernet</li> <li>IP Services software feature set (IPS)</li> <li>Provides full IPv6 dynamic routing</li> </ul>
<b>WS-C3560-48PS-S</b>	<ul style="list-style-type: none"> <li>48 Ethernet 10/100 ports and 4 SFP-based Gigabit Ethernet ports</li> <li>1RU fixed-configuration, multilayer switch</li> <li>Enterprise-class intelligent services delivered to the network edge</li> <li>IEEE 802.3af and Cisco prestandard Power over Ethernet</li> <li>IP Base software feature set (IPB)</li> </ul>
<b>WS-C3560-48PS-E</b>	<ul style="list-style-type: none"> <li>48 Ethernet 10/100 ports and 4 SFP-based Gigabit Ethernet ports</li> <li>1RU fixed-configuration, multilayer switch</li> <li>Enterprise-class intelligent services delivered to the network edge</li> <li>IEEE 802.3af and Cisco prestandard Power over Ethernet</li> <li>IP Services software feature set (IPS)</li> <li>Provides full IPv6 dynamic routing</li> </ul>
<b>WS-C3560G-24TS-S</b>	<ul style="list-style-type: none"> <li>24 Ethernet 10/100/1000 ports and 4 SFP-based Gigabit Ethernet ports</li> <li>1RU fixed-configuration, multilayer switch</li> <li>Enterprise-class intelligent services delivered to the network edge</li> <li>IP Base software feature set (IPB)</li> </ul>
<b>WS-C3560G-24TS-E</b>	<ul style="list-style-type: none"> <li>24 Ethernet 10/100/1000 ports and 4 SFP-based Gigabit Ethernet ports</li> <li>1RU fixed-configuration, multilayer switch</li> <li>Enterprise-class intelligent services delivered to the network edge</li> <li>IP Services software feature set (IPS)</li> <li>Provides full IPv6 dynamic routing</li> </ul>
<b>WS-C3560G-48TS-S</b>	<ul style="list-style-type: none"> <li>48 Ethernet 10/100/1000 ports and 4 SFP-based Gigabit Ethernet ports</li> <li>1RU fixed-configuration, multilayer switch</li> <li>Enterprise-class intelligent services delivered to the network edge</li> <li>IP Base software feature set (IPB)</li> </ul>
<b>WS-C3560G-48TS-E</b>	<ul style="list-style-type: none"> <li>48 Ethernet 10/100/1000 ports and 4 SFP-based Gigabit Ethernet ports</li> <li>1RU fixed-configuration, multilayer switch</li> <li>Enterprise-class intelligent services delivered to the network edge</li> <li>IP Services software feature set (IPS)</li> <li>Provides full IPv6 dynamic routing</li> </ul>
<b>WS-C3560G-24PS-S</b>	<ul style="list-style-type: none"> <li>24 Ethernet 10/100/1000 ports and 4 SFP-based Gigabit Ethernet ports</li> <li>1RU fixed-configuration, multilayer switch</li> <li>Enterprise-class intelligent services delivered to the network edge</li> <li>IEEE 802.3af and Cisco prestandard</li> <li>IP Base software feature set (IPB)</li> </ul>

<b>WS-C3560G-24PS-E</b>	<ul style="list-style-type: none"> <li>• 24 Ethernet 10/100/1000 ports and 4 SFP-based Gigabit Ethernet ports</li> <li>• 1RU fixed-configuration, multilayer switch</li> <li>• Enterprise-class intelligent services delivered to the network edge</li> <li>• IEEE 802.3af and Cisco prestandard Power over Ethernet</li> <li>• IP Services software feature set (IPS)</li> <li>• Provides full IPv6 dynamic routing</li> </ul>
<b>WS-C3560G-48PS-S</b>	<ul style="list-style-type: none"> <li>• 48 Ethernet 10/100/1000 ports and 4 SFP-based Gigabit Ethernet ports</li> <li>• 1RU fixed-configuration, multilayer switch</li> <li>• Enterprise-class intelligent services delivered to the network edge</li> <li>• IEEE 802.3af and Cisco prestandard Power over Ethernet</li> <li>• IP Base software feature set (IPB)</li> </ul>
<b>WS-C3560G-48PS-E</b>	<ul style="list-style-type: none"> <li>• 48 Ethernet 10/100/1000 ports and 4 SFP-based Gigabit Ethernet ports</li> <li>• 1RU fixed-configuration, multilayer switch</li> <li>• Enterprise-class intelligent services delivered to the network edge</li> <li>• IEEE 802.3af and Cisco prestandard Power over Ethernet</li> <li>• IP Services software feature set (IPS)</li> <li>• Provides full IPv6 dynamic routing</li> </ul>
<b>CD-3560G-EMI=</b>	<ul style="list-style-type: none"> <li>• IP Services License (formerly EMI) upgrade kit for IP Base versions of the Cisco Catalyst 3560G-24TS, Catalyst 3560G-24PS, Catalyst 3560G-48TS and Catalyst 3560G-48PS</li> <li>• Advanced IPv6 routing</li> </ul>
<b>CD-3560-EMI=</b>	<ul style="list-style-type: none"> <li>• IP Services License (formerly EMI) upgrade kit for IP Base versions of the Cisco Catalyst 3560-24PS, Catalyst 3560-48PS, Catalyst 3560-24TS, Catalyst 3560-48TS, and Catalyst 3560-8PC</li> <li>• Advanced IPv6 routing</li> </ul>
<b>PWR-RPS2300</b>	Cisco RPS 2300 with one connector cable
<b>RCKMNT-1RU=</b>	Spare rack-mount kit for the Cisco Catalyst 3560
<b>RCKMNT-REC-1RU=</b>	1RU recessed rack-mount kit for the Cisco Catalyst 3560
<b>RCKMNT-19-CMPCT=</b>	Rack-mount kit for the Cisco Catalyst 3560-8PC and Catalyst 3560-12PC compact switches
<b>CBLGRD-C3560-8PC=</b>	Cable guard for the Cisco Catalyst 3560-8PC compact switch
<b>CBLGRD-C3560-12PC=</b>	Cable guard for the Cisco Catalyst 3560-12PC compact switch
<b>GLC-LH-SM=</b>	1000BASE-LX/LH SFP transceiver module for MMF and SMF, 1300-nm wavelength
<b>GLC-SX-MM=</b>	1000BASE-SX SFP transceiver module for MMF, 850-nm wavelength
<b>GLC-ZX-SM=</b>	1000BASE-ZX SFP transceiver module for SMF, 1550-nm wavelength
<b>GLC-T=</b>	1000BASE-T SFP transceiver module for Category 5 copper wire Not supported on the Cisco Catalyst 3560-8PC compact switch
<b>GLC-BX-D=</b>	1000BASE-BX10 SFP transceiver module for single strand SMF, 1490-nm TX / 1310-nm RX wavelength
<b>GLC-BX-U=</b>	1000BASE-BX10 SFP transceiver module for single strand SMF, 1310-nm TX / 1490-nm RX wavelength
<b>GLC-GE-100FX=</b>	<ul style="list-style-type: none"> <li>• 100BASE-FX SFP transceiver module for Gigabit Ethernet ports, 1310 nm wavelength, 2 km over MMF</li> <li>• Not supported on the Cisco Catalyst 3560-8PC and Catalyst 3560-12PC compact switches</li> </ul>
<b>GLC-FE-100FX=</b>	<ul style="list-style-type: none"> <li>• 100BASE-FX SFP transceiver module for 100-Mb ports, 1310 nm wavelength, 2 km over MMF</li> <li>• Only supported on the Cisco Catalyst 3560-8PC and Catalyst 3560-12PC compact switches</li> </ul>
<b>GLC-FE-100LX=</b>	<ul style="list-style-type: none"> <li>• 100BASE-FX SFP transceiver module for 100-Mb ports, 1310 nm wavelength, 10 km over SMF</li> <li>• Only supported on the Cisco Catalyst 3560-8PC and Catalyst 3560-12PC compact switches</li> </ul>
<b>GLC-FE-100BX-D=</b>	<ul style="list-style-type: none"> <li>• 100BASE-BX10-D SFP transceiver module for 100-Mb ports, 1550 nm TX / 1310 nm RX wavelength, 10 km over single-strand SMF</li> <li>• Only supported on the Cisco Catalyst 3560-8PC and Catalyst 3560-12PC compact switches</li> </ul>

<b>GLC-FE-100BX-U=</b>	<ul style="list-style-type: none"> <li>• 100BASE-BX10-U SFP transceiver module for 100-Mb ports, 1310 nm TX/1550 nm RX wavelength, 10 km over single-strand SMF</li> <li>• Only supported on the Cisco Catalyst 3560-8PC and Catalyst 3560-12PC compact switches</li> </ul>
<b>CWDM-SFP-1470=</b>	Cisco CWDM SFP 1470 nm; Gigabit Ethernet and 1G/2G FC (gray)
<b>CWDM-SFP-1490=</b>	Cisco CWDM SFP, 1490 nm; Gigabit Ethernet and 1G/2G FC (violet)
<b>CWDM-SFP-1510=</b>	Cisco CWDM SFP, 1510 nm; Gigabit Ethernet and 1G/2G FC (blue)
<b>CWDM-SFP-1530=</b>	Cisco CWDM SFP, 1530 nm; Gigabit Ethernet and 1G/2G FC (green)
<b>CWDM-SFP-1550=</b>	Cisco CWDM SFP, 1550 nm; Gigabit Ethernet and 1G/2G FC (yellow)
<b>CWDM-SFP-1570=</b>	Cisco CWDM SFP, 1570 nm; Gigabit Ethernet and 1G/2G FC (orange)
<b>CWDM-SFP-1590=</b>	Cisco CWDM SFP, 1590 nm; Gigabit Ethernet and 1G/2G FC (red)
<b>DWDM-SFP-3033=</b>	DWDM SFP 1530.33 nm SFP (100 GHz ITU grid)
<b>DWDM-SFP-3112=</b>	DWDM SFP 1531.12 nm SFP (100 GHz ITU grid)
<b>DWDM-SFP-3190=</b>	DWDM SFP 1531.90 nm SFP (100 GHz ITU grid)
<b>DWDM-SFP-3268=</b>	DWDM SFP 1532.68 nm SFP (100 GHz ITU grid)
<b>DWDM-SFP-3425=</b>	DWDM SFP 1534.25 nm SFP (100 GHz ITU grid)
<b>DWDM-SFP-3504=</b>	DWDM SFP 1535.04 nm SFP (100 GHz ITU grid)
<b>DWDM-SFP-3582=</b>	DWDM SFP 1535.82 nm SFP (100 GHz ITU grid)
<b>DWDM-SFP-3661=</b>	DWDM SFP 1536.61 nm SFP (100 GHz ITU grid)
<b>DWDM-SFP-3819=</b>	DWDM SFP 1538.19 nm SFP (100 GHz ITU grid)
<b>DWDM-SFP-3898=</b>	DWDM SFP 1538.98 nm SFP (100 GHz ITU grid)
<b>DWDM-SFP-3977=</b>	DWDM SFP 1539.77 nm SFP (100 GHz ITU grid)
<b>DWDM-SFP-4056=</b>	DWDM SFP 1540.56 nm SFP (100 GHz ITU grid)
<b>DWDM-SFP-4214=</b>	DWDM SFP 1542.14 nm SFP (100 GHz ITU grid)
<b>DWDM-SFP-4294=</b>	DWDM SFP 1542.94 nm SFP (100 GHz ITU grid)
<b>DWDM-SFP-4373=</b>	DWDM SFP 1543.73 nm SFP (100 GHz ITU grid)
<b>DWDM-SFP-4453=</b>	DWDM SFP 1544.53 nm SFP (100 GHz ITU grid)
<b>CWDM-SFP-1610=</b>	Cisco CWDM SFP, 1610 nm; Gigabit Ethernet and 1G/2G FC (brown)
<b>CAB-SFP-50CM=</b>	Cisco Catalyst 3560 SFP Interconnect Cable (50 dcm)
<b>CAB-SM-LCSC-1M</b>	1m-fiber single-mode LC-to-SC connectors
<b>CAB-SM-LCSC-5M</b>	5m-fiber single-mode LC-to-SC connectors

For more information about Cisco products, contact:

- United States and Canada: (toll free) 800 553-NETS (6387)
- Europe: 32 2 778 4242
- Australia: 612 9935 4107
- Other: 408 526-7209

World Wide Web URL: <http://www.cisco.com>



**Americas Headquarters**  
Cisco Systems, Inc.  
San Jose, CA

**Asia Pacific Headquarters**  
Cisco Systems (USA) Pte. Ltd.  
Singapore

**Europe Headquarters**  
Cisco Systems International BV  
Amsterdam, The Netherlands

Cisco has more than 200 offices worldwide. Addresses, phone numbers, and fax numbers are listed on the Cisco Website at [www.cisco.com/go/offices](http://www.cisco.com/go/offices).

CCDE, CCENT, CCSI, Cisco Eos, Cisco HealthPresence, Cisco IronPort, the Cisco logo, Cisco Lumin, Cisco Nexus, Cisco Nurse Connect, Cisco StackPower, Cisco StadiumVision, Cisco TelePresence, Cisco Unified Computing System, Cisco WebEx, DCE, Flip Channels, Flip for Good, Flip Mino, Flip Video, Flip Video (Design), Flipshare (Design), Flip Ultra, and Welcome to the Human Network are trademarks; Changing the Way We Work, Live, Play, and Learn, Cisco Store, and Flip Gift Card are service marks; and Access Registrar, Aironet, AsyncOS, Bringing the Meeting To You, Catalyst, CCDA, CCDP, CCIE, CCIP, CCNA, CCNP, CCSP, CCVP, Cisco, the Cisco Certified Internetwork Expert logo, Cisco IOS, Cisco Press, Cisco Systems, Cisco Systems Capital, the Cisco Systems logo, Cisco Unity, Collaboration Without Limitation, EtherFast, EtherSwitch, Event Center, Fast Step, Follow Me Browsing, FormShare, GigaDrive, HomeLink, Internet Quotient, IOS, iPhone, iQuick Study, IronPort, the IronPort logo, LightStream, Linksys, MediaTone, MeetingPlace, MeetingPlace Chime Sound, MGX, Networkers, Networking Academy, Network Registrar, PCNow, PIX, PowerPanels, ProConnect, ScriptShare, SenderBase, SMARTnet, Spectrum Expert, StackWise, The Fastest Way to Increase Your Internet Quotient, TransPath, WebEx, and the WebEx logo are registered trademarks of Cisco Systems, Inc. and/or its affiliates in the United States and certain other countries.

All other trademarks mentioned in this document or website are the property of their respective owners. The use of the word partner does not imply a partnership relationship between Cisco and any other company. (0907R)



**DATASHEET    CAMARA    PTZ**  
**HIKVISION**

# DS-2DE5174-AE

## 1.3MP PTZ Dome Network Camera



### Key features

- 1/3" Progressive Scan CMOS
- 1280 x 960 HD resolution
- 20X optical zoom, 16X digital zoom
- True Day/Night, 3D DNR, Digital WDR
- 3D intelligent positioning
- Support 24VAC / PoE+ power supply

### Dimensions

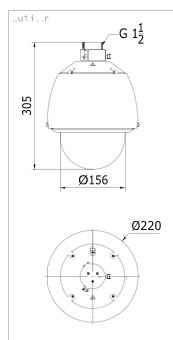

### Accessories



DS-2DE5174-AE	
<b>Camera</b>	
Image Sensor	1/3" Progressive Scan CMOS
Effective Pixel	1320K pixels
Min. Illumination	Color: 0.05Lux@(F1.4, AGC ON), B/W: 0.01Lux@(F1.4, AGC ON)
White Balance	Auto / Manual / ATW / Indoor / Outdoor / Daylight lamp / Sodium lamp
AGC	Auto / Manual
S / N Ratio	≥ 50dB
Digital Noise Reduction	3D DNR
Backlight Compensation	BLC
Wide Dynamic Range	128X Digital WDR
Shutter Speed	1 ~ 1/10,000s
Day & Night	IR Cut Filter
Digital Zoom	16X
Focus Mode	Auto / Semiautomatic / Manual
<b>Lens</b>	
Focal Length	4.7 ~ 94.0mm, 20x
Zoom Speed	Approx. 3s (Optical Wide-Tele)
Angle of View	58.3 ~ 3.2 degree (Wide-Tele)
Min. Working Distance	10 ~ 1,000mm (Wide-Tele)
Aperture Range	F1.4 ~ F3.5
<b>Pan and Tilt</b>	
Pan / Tilt Range	Pan: 360° endless; Tilt: -5° ~ 90° (Auto Flip)
Pan / Tilt Speed	Pan Manual Speed: 0.1° ~ 250°/s, Pan Preset Speed: 300°/s Tilt Manual Speed: 0.1° ~ 150°/s, Tilt Preset Speed: 200°/s
Proportional Zoom	Rotation speed can be adjusted automatically according to zoom multiples
Number of Preset	256
Patrol	8 patrols, up to 32 presets per patrol
Park action	Pattern / Pan scan / Tilt scan / Random scan / Frame scan / Panorama scan
<b>Input/ Output</b>	
Audio Input	Optional audio input (Line input), 2 ~ 2.4V(p-p); output impedance: 1KΩ±10%
Audio Output	Line level, impedance: 600 Ω
<b>Network</b>	
Ethernet	10Base-T / 100Base-TX, RJ45 connector
Max. Image Resolution	1280x960
Frame Rate	60Hz: 30fps(1280x960), 30fps(1280x720)
Image Compression	H.264 / MPEG4
Audio Compression	G.711u / G.711a / G.726
Protocols	IPv4/IPv6, HTTP, HTTPS, 802.1x, QoS, FTP, SMTP, UPnP, SNMP, DNS, DDNS, NTP, RTSP, RTP, TCP/IP, UDP, IGMP, ICMP, DHCP, PPPoE
Simultaneous Live View	Up to 6
Streams	Dual Streams
Mini SD Memory Card	Micro SD Slot, up to 32GB
User/Host Level	Up to 32 users, 3 Levels: Administrator, Camera control, Live view only
Security Measures	User authentication (ID and PW), Host authentication (MAC address)
<b>Integration</b>	
Application programming	Open-ended API, support Onvif, PSIA and CGI
Web Browser	IE 7, IE 8, IE 9, Chrome 8+, Firefox 3.5+, Safari 5+
<b>General</b>	
RS-485 Protocols	HIKVISION, Pelco-P, Pelco-D, self-adaptive
Power	24 VAC/PoE+ Max. 22W/14W (Heater On / Off)
Working Temperature	Outdoor dome: -30°C ~ 65°C (-22°F ~ 149°F)
Humidity	90% or less
Protection Level	IP66 standard (outdoor dome) TVS 4,000V lightning protection, surge protection and voltage transient protection
Dimensions	Φ220x305mm (Φ8.66"x12.02") (Outdoor)
Weight (approx.)	5Kg (11.02lbs)
Mount Option (for outdoor models)	Long-arm wall mount: WMP-L; Corner mount: WMP-L + CMP; Pole Mount: WMP-L + PMP

### Order models

DS-2DE5174-AE

# **DATASHEET NVR HIKVISION**

# DS-9632/9664NI-XT

## Embedded NVR

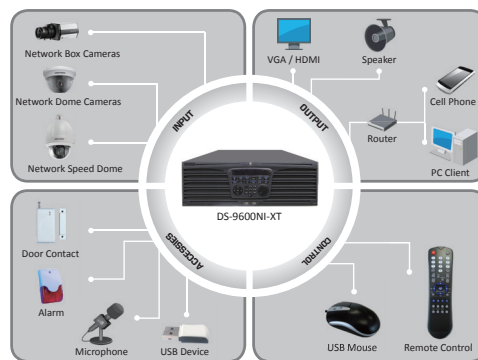

### Key features

- Third-party network cameras supported
- Up to 5 Megapixels resolution recording
- HDMI and VGA output at up to 1920x1080P resolution
- Up to 16 SATA interfaces
- HDD quota and group management
- Dual gigabit network interfaces

### Rear Panel of DS-9600NI-XT

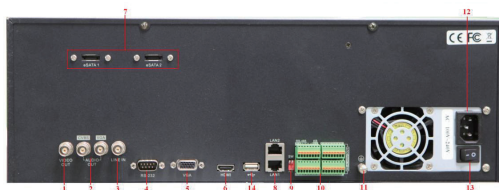

1. Video out
2. CVBS audio out and VGA audio out
3. Line in
4. RS-232 serial interface
5. VGA interface
6. HDMI interface
7. eSATA interface
8. LAN1, LAN2 network interface
9. Termination switch
10. RS-485 serial interface, keyboard interface, Alarm in and Alarm out
11. GND
12. 100 ~ 240VAC Power input
13. Power switch
14. USB interface

	DS-9632NI-XT	DS-9664NI-XT
<b>Video/Audio input</b>		
IP video input	32-ch	64-ch
Two-way audio input	1-ch, BNC (2.0 Vp-p, 1kΩ)	
Incoming bandwidth	160 Mbps	
<b>Video/Audio output</b>		
Recording resolution	5MP / 3MP / 1080P / UXGA / 720P / VGA / 4CIF / DCIF / 2CIF / CIF / QCIF	
CVBS output	1-ch, BNC (1.0 Vp-p, 75 Ω) Resolution: 704 × 576 (PAL); 704 × 480 (NTSC)	
HDMI output	1-ch, resolution: 1920 × 1080P /60Hz, 1920×1080P / 50Hz, 1600 × 1200 /60Hz, 1280 × 1024 /60Hz, 1280 × 720 /60Hz, 1024 × 768 /60Hz	
VGA output	1-ch, resolution: 1920 × 1080P /60Hz, 1600 × 1200 /60Hz, 1280 × 1024 /60Hz, 1280 × 720 /60Hz, 1024 × 768 /60Hz	
Audio output	2-ch, BNC (Linear, 600Ω)	
Playback resolution	5MP / 3MP / 1080P / UXGA / 720P / VGA / 4CIF / DCIF / 2CIF / CIF / QCIF	
Synchronous playback	16-ch	
<b>Hard disk</b>		
SATA	16 SATA interfaces for 16 HDDs	
eSATA	2 eSATA interfaces	
Capacity	Up to 4 TB capacity for each disk	
<b>External interface</b>		
Network interface	2 RJ-45 10 / 100 / 1000 Mbps self-adaptive Ethernet interfaces	
Serial interfaces	1 RS-232 interface (for parameters configuration, maintenance, transparent channel); 1 RS-485 interface (reserved); 1 RS-485 keyboard interface (for special keyboard control)	
USB interface	3 × USB2.0	
Alarm in	16	
Alarm out	4	
<b>General</b>		
Power supply	100 ~ 240 VAC, 6.3A, 50 ~ 60Hz	
Consumption	≤45W	
Working temperature	-10°C ~ +55°C (14 °F ~ 131 °F)	
Working humidity	10% ~ 90%	
Chassis	19-inch rack-mounted 3U chassis	
Dimensions (W × D × H)	445 × 496 × 146 mm (17.5" × 19.5" × 5.7")	
Weight	≤ 12.5 kg / 27.6 lb (without hard disk or DVD-R/W)	